

OWNERS MANUAL

MANUAL NO. 657441

9/05/07

KOYKER[®]

310

LOADER

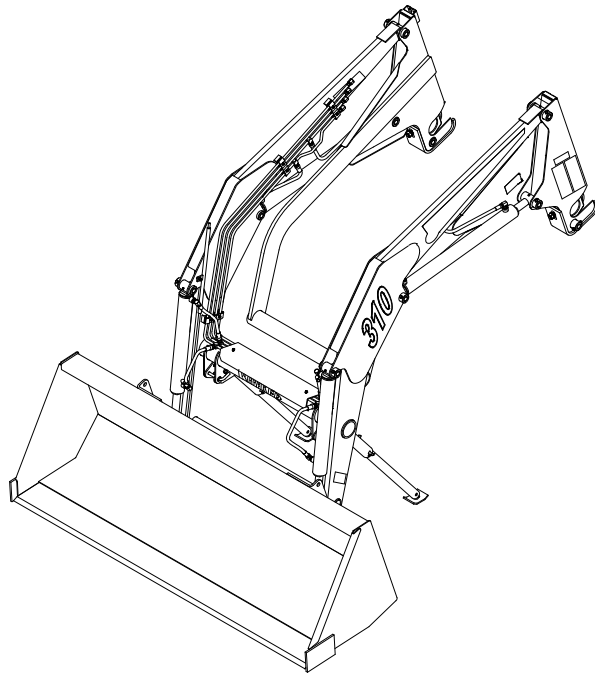

**IMPORTANT - KOYKER DEALER
BE SURE THIS MANUAL IS GIVEN TO THE
PURCHASER FOR FUTURE REFERENCE
KOYKER MANUFACTURING CO., P.O. BOX 409
LENNOX, SD 57039**

Phone 1-800-456-1107 E-mail koyker@koykermfg.com

CONTENTS

CONTENTS	PAGE
Introduction.....	1
SAFETY INFORMATION	
Safety Alert Symbol.....	2
Safety Information	3-5
Safety Decals	6
Tractor & Safety Pointers	7
ASSEMBLY INSTRUCTIONS	
Attaching Loader	8
Attaching Bucket	8
Detaching Loader.....	9
OPERATING INSTRUCTIONS	
Operation.....	10
SERVICE AND MAINTENANCE	
Specifications	11
Loader Inspection, Service, and Maintenance	12
Hydraulic System Parts Schedule	13
Hydraulic System Part Diagram	14
“310” Loader Parts Diagram.....	15
Part Identification Schedule	16-17
Hydraulic Cylinder Information	18
Hydraulic Information	19
2 1/2” Cylinder Service Kit.....	20
Hydraulic Cylinder Parts Schedule.....	21
Hydraulic Cylinder Part Diagram	22
Piston and Gland Diagram	23
Dinoil Valve Hookup.....	24
LIMITED WARRANTY INFORMATION	
Limited Warranty.....	25-27
TORQUE SPECIFICATIONS	
Torque Specifications	28

INTRODUCTION

During a considerable period of time, Koyker Manufacturing Company of Lennox, South Dakota, made a study of the farm loader industry and concluded that the farmer needs a loader that provides fast attachment, quality, dependability, few parts, ruggedness, good delivery, and ease of maintenance, all at a fair price. The fast attaching "310" Farm Loader has achieved these goals. With proper care and handling, it will give many years of good service in normal farm operations.

Please be sure to follow the manual and give it proper care.

TO THE PURCHASER

You have purchased an excellent product. With proper care and use, it will give you years of good safe service. Use only **KOYKER** or **KOYKER** approved parts in the general maintenance and repair of your equipment. **Please fill out ownership registration card as soon as possible.**

Should you have any questions, comments, improvement, or suggestions regarding the contents of any of the manuals provided, please contact Koyker Manufacturing Company (800-456-1107 or E-mail koyker@koykermfg.com).

We care about your safety!

Remember ALL safety decals are no charge from the factory. Please replace all safety decals if missing or damaged. Your safety is important to us.

SAFETY ALERT SYMBOL

The symbol shown below is used to call your attention to instructions concerning your personal safety. Watch for this symbol it points out important safety precautions. It means **ATTENTION! Become Alert! Your Personal Safety Is Involved!**

Read the message that follows and be alert to the possibility of personal injury or death.

DANGER: Indicates an imminently hazardous situation that, if not avoided, will result in death or serious injury.

WARNING: Indicates a potentially hazardous situation that, if not avoided, could result in death or serious injury.

CAUTION: Indicates a potentially hazardous situation that, if not avoided may result in minor or moderate injury.



WARNING!

Anyone who will operate or work around a front-end loader should first read this manual.

SAFETY

Improper use of a loader can cause serious injury or death. The following safety precautions, and those given on the tractor mount installation instructions, should be thoroughly understood before attempting to operate this machine.

BEFORE OPERATING:

Carefully study and understand this manual, the specific tractor mount instructions, and the attachment(s) manual(s).

Prior to operation, inspect the loader for system leaks and damaged, missing, or malfunctioning components in an effort to avoid the possibility of a dangerous failure involving structural members or hydraulic system components.

Be certain any repairs necessary are completed prior to loader operation.

Follow recommended maintenance procedures and precautions on Page 13.

Completely familiarize yourself and others involved with the operation of the hydraulic control valve before operating the loader.

Be certain all bystanders are clear of the machine and operation area prior to operation.

It may be necessary to add wheel ballast or rear weights as recommended by the tractor manufacturer to maintain stability of the machine to prevent tipping or upset which could result in serious injury or death. See mounting instructions for specific information.

It is recommended that both front and rear wheel treads be set to the widest recommended width to prevent tipping or upset which could result in serious injury or death.

This loader is designed for farm type operations such as snow removal, barn and feedlot cleaning, light commercial or light grading and digging. It's design is **NOT** intended for industrial use.

DURING OPERATION:

Never operate the machine other than from the tractor operator's seat.

Be sure operating area is clear of others during machine operations.

Never lift, hoist, or carry humans in the bucket or on any portion of the loader or loader attachments. Failure to heed, may result in serious injury or death.

SAFETY CONTINUED

Transport the machine load at the slowest speed possible and with the loader boom at the lowest transport position to avoid tipping or upsetting, which may result in serious injury or death.

Be extremely careful when working on inclines or near loose fill, rocks, and holes as they can cause tipping or upsetting which may result in serious injury or death.

Be certain to avoid overhead electrical wires when operating loader. Contact with power lines may cause serious injury or death.

Avoid sudden stops when lowering or lifting the loader boom to prevent loss of control over the machine and/or load, which may result in serious injury or death.

Use maximum ballast and the widest recommended wheel setting on your tractor when handling large shiftable loads.

Never attempt to ram with the bucket at high speed or full tractor power. Sudden impact may result in structural failure and possible serious injury or death.

Never adjust or perform maintenance on the loader or tractor with the unit in motion, or without power source locked out.

Never get under bucket or lift arms or reach through the lift arms or bucket linkage when the loader is in operation. Inadvertent movement may cause serious injury or death.

FOLLOWING OPERATION:

Whenever the machine is not in operation, lower the loader boom and set the tractor brakes, disengage drive, shut the engine off, and remove the ignition key before dismounting the tractor.

If loader is to be disengaged from tractor, be sure the loader is securely supported on a hard, level surface and the stand is securely engaged. Be certain all connections between tractor and loader are free before disengaging.

TRANSPORTING:

Use safety lights and SMV emblem in addition to whatever local codes require when equipment is being transported on the road or highway. Check with proper authorities for legal limitations.

Transport all loads at a slow and safe speed.

Carry the load as low as possible and maintain adequate visibility and good round clearance at all times.

SAFETY CONTINUED

PERFORMING MAINTENANCE:

Carefully review, understand, and follow the “maintenance” section in this owners manual before attempting to service loader.

Lower the bucket or attachment to the ground, shut off tractor engine, and relieve pressure in the hydraulic system before adjusting, lubricating, or servicing the loader.

Escaping hydraulic oil under pressure can penetrate the skin. Never use any part of your body to check for hydraulic leaks. Use cardboard when checking for leaks. See Fig. 5-1. Relieve hydraulic pressure before disconnecting any hydraulic line. Failure to heed may result in serious injury or death.

Before disconnecting hydraulic lines, lower the loader and attachments. Lock out the hydraulic supply and relieve all hydraulic pressure.

Replace any damaged or painted-over decals. See Page 8 for replacement decals.

REMEMBER:

1. Move Slowly!
2. Always use care and common sense!
3. Be careful for your own sake and for that of others!
4. Koyker Mfg. Co. includes all reasonable means for accident prevention except a safe and careful operator.

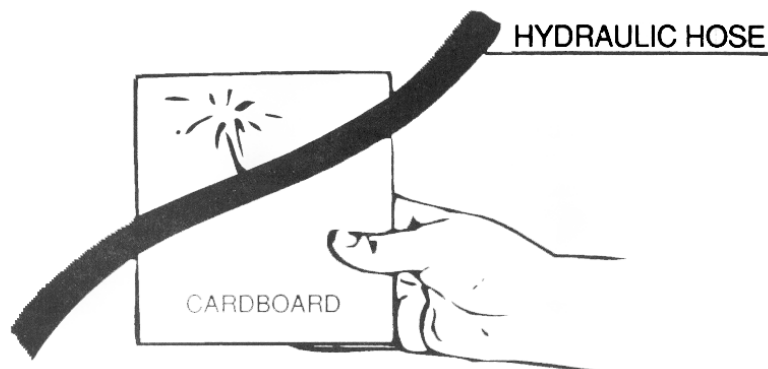
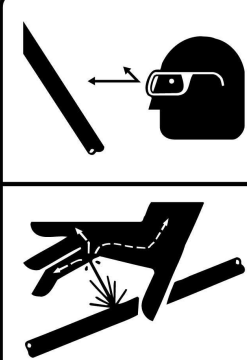

FIG. 5-1

SAFETY DECALS

	<h2 style="margin: 0;">⚠ WARNING</h2>
	<p style="text-align: center;">HIGH-PRESSURE FLUID HAZARD</p> <p>To prevent serious injury or death:</p> <ul style="list-style-type: none"> • Relieve pressure on hydraulic system before servicing or disconnecting hoses. • Wear proper hand and eye protection when searching for leaks. Use wood or cardboard instead of hands. • Keep all components in good repair. • Refer to owners manual if injury should occur.
	666943



<h2 style="margin: 0;">⚠ WARNING</h2>

<p>To avoid injury or death caused by falling loads:</p> <ul style="list-style-type: none"> • Do not handle round bales unless loader is equipped with approved bale handling attachments. • Handle raised loads with caution • Carry load low • Read operators manual
<h2 style="margin: 0;">⚠ WARNING</h2>

<p>To avoid injury from falls:</p> <ul style="list-style-type: none"> • Do not work from or allow riders on loaders or its attachments <p>KOYKER MFG CO. INCLUDES ALL REASONABLE MEANS FOR ACCIDENT PREVENTION EXCEPT A SAFE AND CAREFUL OPERATOR.</p>
666944

<h2 style="margin: 0;">⚠ WARNING</h2>

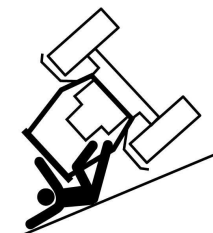
<p>To avoid injury from falling loader:</p> <ul style="list-style-type: none"> • Do not walk or perform service under a raised loader. • Lower loader to ground when parked. <p>KOYKER MFG CO. INCLUDES ALL REASONABLE MEANS FOR ACCIDENT PREVENTION EXCEPT A SAFE AND CAREFUL OPERATOR.</p>
666946

<h2 style="margin: 0;">⚠ DANGER</h2>

<p>Serious injury or death can result from rollovers.</p> <ul style="list-style-type: none"> • Use rops and seatbelt at all times. • Add required rear ballast. • Move wheels to widest recommended setting. • Operate tractor at low seeds. • Carry all loads close to ground.
<h2 style="margin: 0;">⚠ DANGER</h2>

<p>Serious injury or death can result from contact with electric lines.</p> <p>KOYKER MFG CO. INCLUDES ALL REASONABLE MEANS FOR ACCIDENT PREVENTION EXCEPT A SAFE AND CAREFUL OPERATOR.</p>
666945

TRACTOR & SAFETY POINTERS

The use of good judgment and common sense is necessary by the operator in using this loader. The front and rear wheels should be set for the widest wheel tread to assure best stability. Use extra caution when rear wheel weights and tire ballast are added to a loader-equipped tractor. **DO NOT** ram into frozen dirt piles, frozen manure piles, ice, etc., with great momentum where sudden shock loads are encountered. Serious and costly damage may result to both the loader and the tractor.

When scraping or back dragging do not extend the attachment cylinders more than one half of the cylinder's stroke. A limited amount of leveling may be done, when the loader valving is arranged with a float control. This will prevent damage to cylinder rods. Never ride in the bucket.

Before operating the loader, be sure no one is standing near it. Only one person, the operator, should be on the tractor. Remain at the controls and under no circumstances leave the tractor unattended with the bucket in a raised position.

Never lift a person in the bucket or walk under a raised bucket.

Never drive your loader-equipped tractor down a hill that is steeper than 15 degrees. Carry all loads low and use care on side hills.

Always keep unused PTO shaft clutch levers disengaged.

Keep hands, feet, and clothing away from all moving parts.

Hydraulic oil, under pressure, can cause injury. Be sure that all connections are tight and that all pressure is relieved before disconnecting any lines.

Care must be taken with your loader cylinders. Nicks, scratches, rust, or other shaft damage can result in worn packing causing cylinder leakage and subnormal performance.

MOVE SLOWLY

USE COMMON SENSE

BE CAREFUL FOR YOUR OWN SAKE AND THAT OF OTHER PEOPLE

ATTACHING LOADER

1. Will the loader on the storage stands, drive the tractor into the frame of the loader. Connect the hydraulic lines from the tractor to the loader.
2. Using the tractor hydraulics, activate the loader cylinders to bring the front cross pipe of the loader level with the front yoke receiver of the tractor. Align the rear receivers of the loader with the rear mount pipes on the tractor. Position the wrap pivot on both sides of the loader to accept the mount pipe.
3. Drive the tractor forward to engage the loader into the tractor mounts.
4. As the tractor is driven forward the wrap pivot will flip up to engage the mount pipe. Drive forward until the mount pipe is fully engaged in the upright receiver.
5. Install and tighten wrap pivot nuts and washers. Periodically check the nuts for tightness and wear.

ATTACHING THE BUCKET

1. For pin on buckets, assemble pins and retaining bolts as shown in the Parts Diagram of this manual. Make sure all retaining bolts are secure and lubricate necessary points. Inspect pin and bolts periodically for tightness and wear.
2. For Fast Attach Buckets, tilt the bucket adapter forward so the top round pipe slides into the receiver on the bucket first. Rotate the bucket back so the two rear pins line up with the holes on the base plates of the bucket. Turn both pins on bucket adapter so they drop through the holes in the base plate of the bucket.

DETACHING LOADER



IMPORTANT:

Never attempt loader detachment on grades which are not reasonably level.

1. For best results, drive tractor with 310 Loader mounted to reasonably level area. Raise loader up slightly and rotate resting stands to the extra hole in the stand plate and replace stand pin. Remove lock pins at bottom of stands. Extend down stands and replace pins.
2. Remove nut from the pivot stud on each upright. Rescrew the nut back on.
3. Back the tractor until the main frame is free of the mounting pipes. Use the tractor hydraulics to lift the loader mainframe sufficiently so it will clear any tractor obstructions. Flatten bucket against the ground. Then uncouple hydraulic hoses and back out of the 310 Loader. Store the hydraulic couplings properly to prevent dirt from getting into system.
4. To attach, enter and hookup merely by reversing the process. As in any other piece of equipment, care should be used until the operator becomes familiar with the mounting and dismounting procedure.

IMPORTANT:

Never store the detached loader where insufficient soil bearing capacity exists. Good firm clay or firmly packed dirt are sufficient, providing the area is dry. If stability is in question, use blocking under the stand foot to disperse the load. Failure to heed, may allow the loader to settle and prevent attachment at a later date.

OPERATION



WARNING:

Never allow anyone to operate the loader until they have carefully reviewed and understood this owners manual.

FILLING THE BUCKET:

When manure is piled on a slope, it is best to drive tractor up the slope straight into the pile. Operating sideways on a slope has a tendency to tip the loading unit. Drive tractor straight into the pile, raise the bucket about six inches, then drop bucket and drive forward until the bucket is filled. Tilt bucket completely back, raise main frame and back away from manure pile.

DUMPING THE BUCKET:

When dumping, bring the bucket to proper dumping height which is just high enough so it will not strike the spreader as the load is being dumped. With the bucket tipped, drive tractor forward and raise the bucket at the same time to distribute the load evenly into spreader or conveyance.

RAISING THE BUCKET:



WARNING:

Make sure material in bucket cannot spill out on to tractor when loader boom is raised. Keep clear of overhead obstructions such as trees, limbs or power lines when raising the bucket.

Side cutting is the best method of reducing large stockpiles. If the sides of the pile are too high, use the loader to pull them down and reduce the possibility of slides.

Make sure you keep all lines, cylinders, and complete hydraulic system free of all sand, dirt, and foreign matter. Use only clean oil in the hydraulic system. When removing the loader from the tractor, be sure to plug all open ports. If the loader will be out of service for several days or longer, grease the exposed polished piston shafts on the bucket and the lift cylinders.

WARNING:



NEVER attempt to operate the loader with someone near the loader frame or bucket.

If this loader is equipped with a Grapple Fork, be sure Grapple Teeth are closed before leaving seat of tractor.

SPECIFICATIONS

KOYKER 310 LOADER SPECIFICATIONS

Description of Equipment Rated

Loader Model.....	310
Bucket Size	6'
Rated Flow	15 GPM
Maximum Pressure	2500 PSI
Lift Cylinder Dia.....	2 1/2" Bore
Attachment Cylinder Dia.	2 1/2" Bore
Tractor Horsepower Range	45-90 HP

Dimensional Specifications

(A) *Maximum Lift Height to Pivot Pin.....	11' 7"
(B) *Lift Height under Level Bucket.....	10' 9"
(C) *Clearance with Bucket Fully Dumped.....	9' 2"
(D) *Reach at Maximum Lift Height.....	2' 9"
(E) Maximum Dump Angle	40°
(F) *Reach with Bucket on Ground.....	6' 3"
(G) Maximum Rollback Angle	16°
(H) *Digging Depth	3"
(J) *Overall Height in Carry Position	5' 11"

Operational Specifications

(U) *Lift Capacity to Maximum Height at Pivot Pin	3590 lbs.
(V) *Lift Capacity to Maximum Height 19.7" Forward of Pivot Pin.....	2430 lbs.
(Y) *Breakout Force at Ground Line at Pivot Pin	4930 lbs.
(Z) *Breakout Force at Ground Line 19.7" Forward of Pivot Pin.....	3550 lbs.
*Raising Time	5 seconds
*Lower Time.....	3 seconds
*Attachment Dumping Time	3 seconds
*Attachment Rollback Time	2 seconds

*Specifications based on ASABE standards S301.3 (Front-End Agricultural Loader Ratings) The above information is based on testing done by Koyker Mfg. Variations in maximum lift height and other specs for different tractors are due to tire sizes, variations in loader mounting locations and hydraulic system efficiency.

Specifications are subject to change without notice and without liability therefore.

LOADER INSPECTION, SERVICE, AND MAINTENANCE

Lower the bucket to the ground, shut off tractor engine, and relieve the pressure in the hydraulic system before adjusting, lubricating, or servicing the loader.

Inspect all pins and grease fittings before each use and lubricate with heavy duty grease as indicated in this manual.

Periodically check all bolts for looseness and re-torque if necessary.

Before storage, be certain all hydraulic cylinders are fully collapsed so that the rod will not be exposed to the elements or damaged.

Be certain hydraulic system remains sealed at all times to prevent contamination.

Check and maintain an adequate fluid level in the tractor reservoir prior to use.

Inspect all hydraulic system hoses and fittings. Replace prior to further operation if damaged.



WARNING!

Escaping hydraulic oil under pressure can penetrate the skin. Never use body to check for hydraulic leaks. Use cardboard when checking for leaks. See Fig. 12-1. Relieve hydraulic pressure before disconnecting any hydraulic line. Failure to heed may result in serious injury or death.

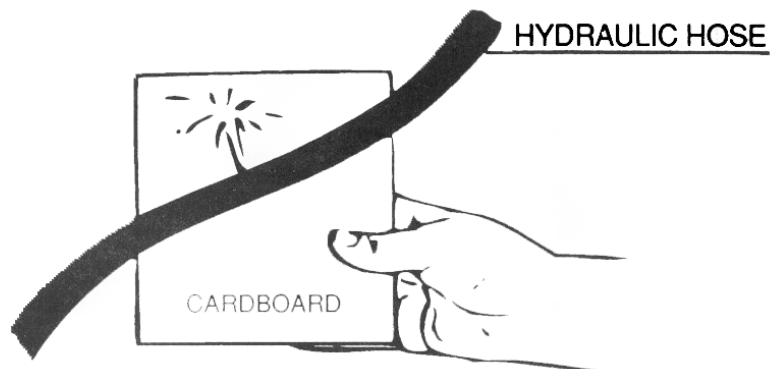
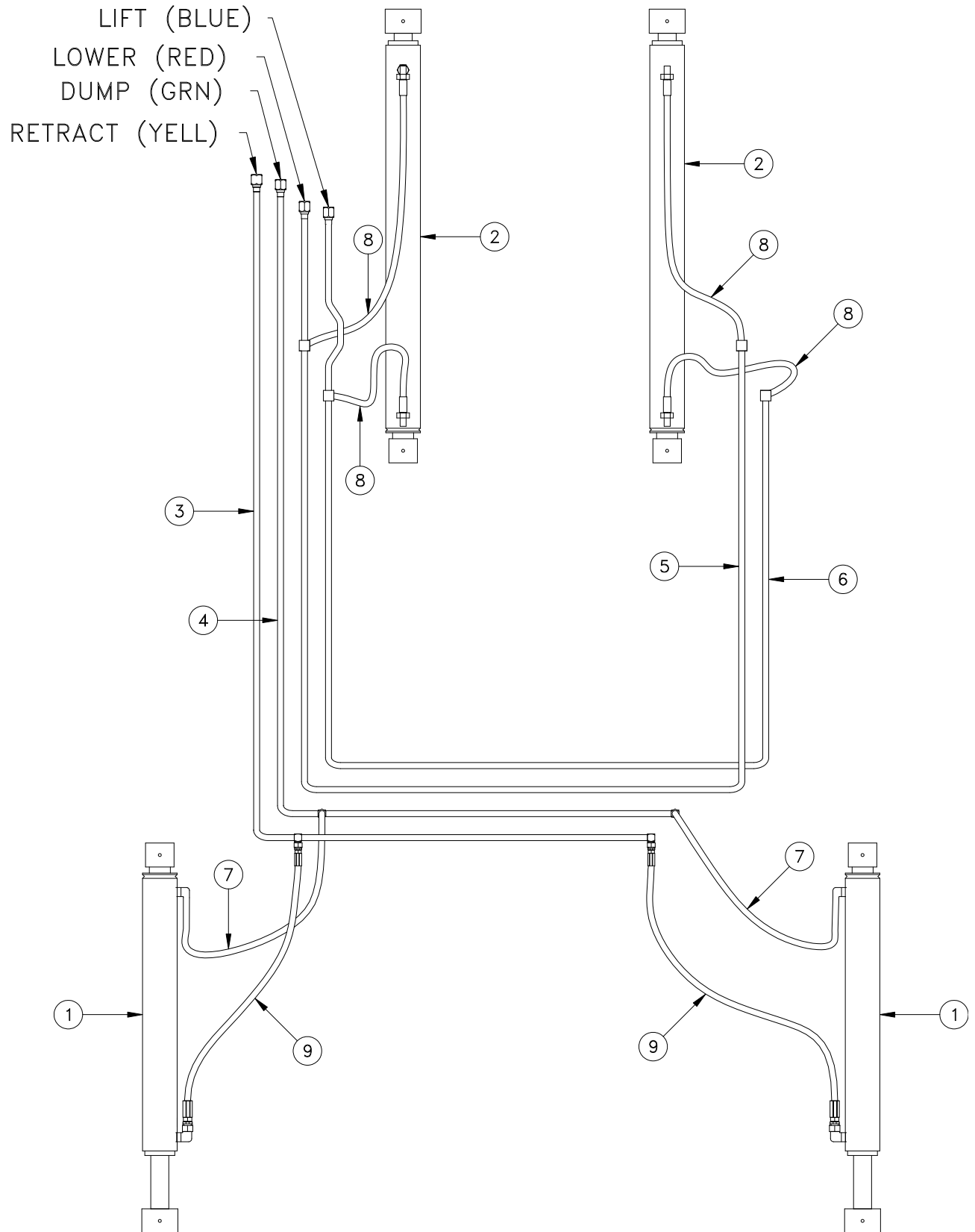

FIG. 12-1

HYDRAULIC SYSTEM PARTS SCHEDULE

KEY	PART NUMBER	DESCRIPTION	QUANTITY
1.....	672415.....	2 1/2" Bucket Cylinder	2
2.....	672412.....	2 1/2" Lift Cylinder	2
3.....	657488.....	1st Oil Line (Yellow).....	1
4.....	657489.....	2nd Oil Line (Green).....	1
5.....	657490.....	3rd Oil Line (Red).....	1
6.....	657491.....	4th Oil Line (Blue).....	1
7.....	655179.....	14" Hydraulic Hose.....	2
8.....	663188.....	18" Hydraulic Hose.....	4
9.....	663328.....	26" Hydraulic Hose.....	2

HYDRAULIC SYSTEM PARTS DIAGRAM



KOYKER "310" LOADER PARTS DIAGRAM

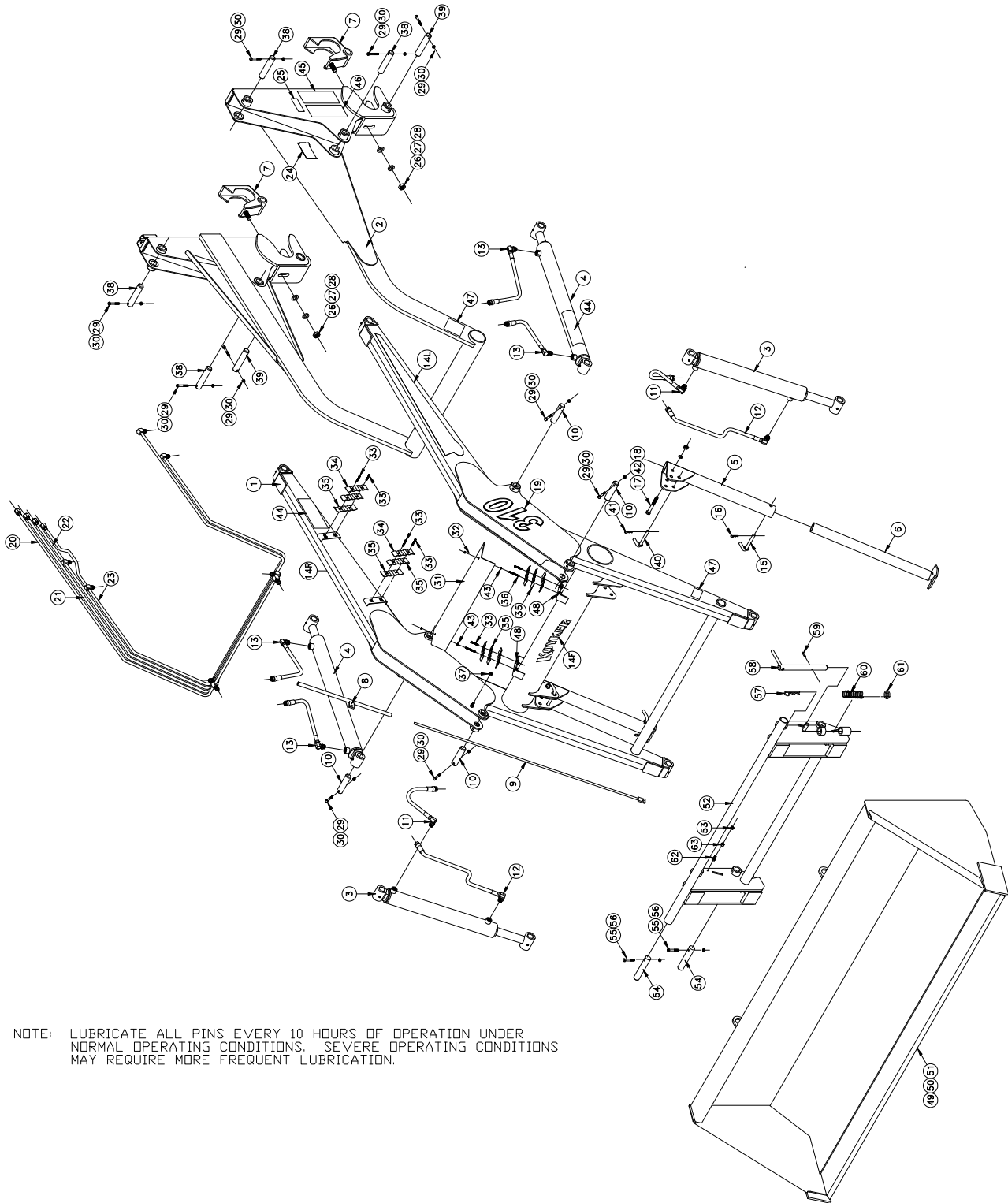

PARTS IDENTIFICATION SCHEDULE

KEY	PART NUMBER	DESCRIPTION	QUANTITY
1.....	656750.....	Main Frame	1
2.....	665260.....	Upright Wrap	1
3.....	672415.....	Bucket Cylinder	2
4.....	672412.....	Lift Cylinder.....	2
5.....	665993.....	Upper Stand	2
6.....	665990.....	Lower Stand	2
7.....	656760.....	Wrap Pivot	2
8.....	657740.....	Indicator Sleeve	1
9.....	657744.....	Indicator Rod	1
10.....	657199.....	Pivot Pin.....	4
11.....	655179.....	14" Hydraulic Hose.....	2
12.....	663328.....	26" Hydraulic Hose.....	2
13.....	663188.....	18" Hydraulic Hose.....	4
14L	677678.....	"Koyker" Decal Left	1
14R	677679.....	"Koyker" Decal Right.....	1
14F	680205.....	"Koyker" Decal Front	1
15.....	641119.....	Lock Pin	2
16.....	640671.....	#3 Hitch Pin Clip	2
17.....	640070.....	HH Cap Screw; 1/2" x 5"	2
18.....	640139.....	Hexnut; 1/2"	2
19.....	677662.....	"310" Decal.....	2
20.....	657488.....	1st Oil Line	1
21.....	657489.....	2nd Oil Line	1
22.....	657490.....	3rd Oil Line.....	1
23.....	657491.....	4th Oil Line	1
24.....	654629.....	"American Made" Decal	2
25.....	666941.....	Serial Number Decal.....	1
26.....	640145.....	Jamnut; 3/4"	2
27.....	640162.....	Lockwasher; 3/4"	2
28.....	640922.....	Flatwasher; 3/4"	2
29.....	640021.....	HH Cap Screw; 5/16" x 2 1/4"	10
30.....	640128.....	Locknut; 5/16"	10
31.....	657198.....	Oil Line Cover	1
32.....	640126.....	Locknut; 1/4"	2
33.....	661665.....	Socket Head Screw; 1/4" x 1 1/4"	8
34.....	661030.....	Wavey Oil Clamp	5
35.....	661016.....	Oil Line Insulator.....	10
36.....	655181.....	Stud; 1/4" x 2 1/2"	2
37.....	654121.....	Locknut; 3/8"	1
38.....	660369.....	Pivot Pin.....	4
39.....	675015.....	Pivot Pin.....	2
40.....	655674.....	Lock Pin	2

PARTS IDENTIFICATION CONTINUED

Optional Fast Attach Buckets, Adapters & Standard Buckets

KEY	PART NUMBER	DESCRIPTION	QUANTITY
41.....	640246.....	#6 Hitch Pin	2
42.....	640157.....	Lockwasher; 1/2"	2
43.....	640127.....	Hexnut; 1/4"	2
44.....	666943.....	Warning Decal	5
45.....	666944.....	Warning Decal	1
46.....	666945.....	Danger Decal	1
47.....	666946.....	Warning Decal	4
48.....	661018.....	Tinnerman Retainer nut	4
49.....	656757.....	6' Fast Attach Bucket.....	1
50.....	656758.....	7' Fast Attach Bucket.....	1
51.....	656759.....	8' Fast Attach Bucket.....	1
	672964	Bucket Adapter Bundle	1
52.....	672965.....	Bucket Adapter	1
53.....	654121.....	Locknut; 3/8"	1
54.....	660369.....	Pivot Pin	4
55.....	640021.....	HH Cap Screw; 5/16" x 2 1/4"	4
56.....	640128.....	Locknut; 5/16"	4
57.....	640246.....	#6 Hitch Pin	2
58.....	654699.....	Latch Pin	2
59.....	650389.....	Spring Pin.....	2
60.....	650388.....	Spring	2
61.....	650390.....	Latch Pin Washer	2
62.....	673012.....	HH Cap Screw; 3/8" x 1 3/4"	1
63.....	640132.....	Nut; 3/8"	1

CYLINDERS

IMPORTANT: Read these service tips before beginning assembly of cylinder gland or piston.

1. Keep seals clean from the time they are removed from package until they are installed.
2. Clean the groove or bore into which the seal is to be fitted before installing the seal.
3. Never touch the seal lip in handling. Always pick up the seal by its outer member.
4. Inspect each seal lip carefully for nicks, scratches, and dirt at time of installation. If dirty use a soft, clean cloth and carefully wipe off seal. **DO NOT wipe seal with fingers, this only imbeds dirt in the seal.**



NEVER clean rubber related seals with a mineral based solvent! Clean rubber seals in denatured alcohol or non-mineral based solvents only.

NOTE: Seals can be made more pliable and easier to install, if first heated in hydraulic oil to 160°F. Never use direct heat on any seals.

HYDRAULIC SYSTEM

The hoses from the tractor valves are attached to the oil lines which are on the inside of the loader main frame.

Re-check all joints to prevent leakage after loader is mounted and in operation.

KEEP SYSTEM CLEAN - USE ONLY CLEAN OIL



CAUTION! It is of utmost importance that the hydraulic system of this loader be kept free from dirt and foreign matter.

All internal parts to the hydraulic system of your loader have been carefully cleaned, inspected, and plugged with protective caps before shipment. All protective caps should be kept in place until the hydraulic system is connected.

NOTE: Over 75 percent of all hydraulic failure and service is caused by dirt, etc. in the system.

REMEMBER - CLEAN OIL MEANS LONGER LIFE!

2 1/2" CYLINDER SERVICE KITS

KIT NO. 662048:

Complete kit with all seals needed to service one (1) 2 1/2" Cylinder. Consists of:

1 each	2 1/2" Gland "O" Ring
1 each	2 1/2" Backup Ring
1 each	1 1/2" U-cup Seal
1 each	1 1/2" Rod Wiper
2 each	2 1/2" U-cup Seal
1 each	1" Rod "O" Ring
1 each	1" Locknut

KIT NO. 663317:

Complete assembled 2 1/2" Cylinder Gland with all seals. Consists of:

1 each	2 1/2" Aluminum Gland
1 each	2 1/2" Gland "O" Ring
1 each	2 1/2" Backup Ring
1 each	1 1/2" U-cup Seal
1 each	1 1/2" Rod Wiper
1 each	1" Locknut

KIT NO. 663318:

Complete assembled 2 1/2" Cylinder Piston with all seals. Consists of:

1 each	2 1/2" Aluminum Piston
2 each	2 1/2" U-cup Seal
1 each	1" Rod "O" Ring
1 each	1" Locknut

KIT NO. 662052:

All seals needed to service one (1) 2 1/2" Cylinder Gland. Consists of:

1 each	2 1/2" Gland "O" Ring
1 each	2 1/2" Backup Ring
1 each	1 1/2" U-cup Seal
1 each	1 1/2" Rod Wiper
1 each	1" Locknut

KIT NO. 662055:

All seals needed to service one (1) 2 1/2" Cylinder Piston. Consists of:

2 each	2 1/2" U-cup Seal
1 each	1" Rod "O" Ring
1 each	1" Locknut

HYDRAULIC CYLINDER PARTS SCHEDULE

2 1/2" CYLINDER PARTS LIST

LIFT CYLINDER (Part No. 672412)

Key	Part No.	Description	Quantity
1.....	672413.....	Tube Weldment.....	1
2.....	661017.....	Locknut	1
3.....	651458.....	Piston Assembly.....	1
4.....	640301.....	"O" Ring Seal	1
5.....	651457	Gland Assembly.....	1
6.....	657070.....	Rod Weldment	1
.....	662048.....	Seal Kit.....	1

BUCKET CYLINDER (Part No. 672415)

Key	Part No.	Description	Quantity
1.....	642416.....	Tube Weldment.....	1
2.....	661017.....	Locknut	1
3.....	651458.....	Piston Assembly.....	1
4.....	640301.....	"O" Ring Seal	1
5.....	651457	Gland Assembly.....	1
6.....	657093.....	Rod Weldment	1
.....	662048.....	Seal Kit.....	1

HYDRAULIC CYLINDER PARTS DIAGRAM

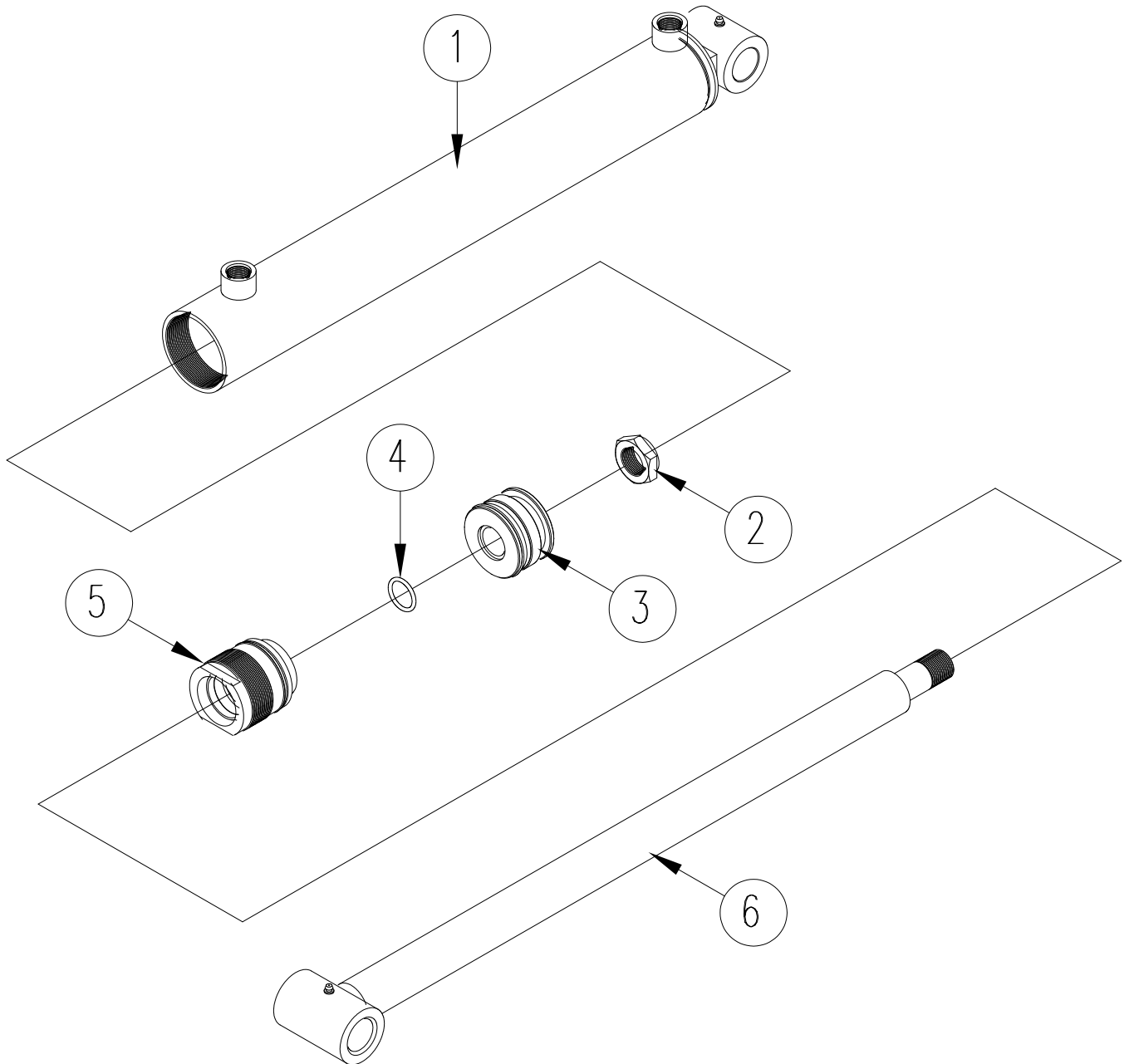

CYLINDER GLAND SERVICE DIAGRAM

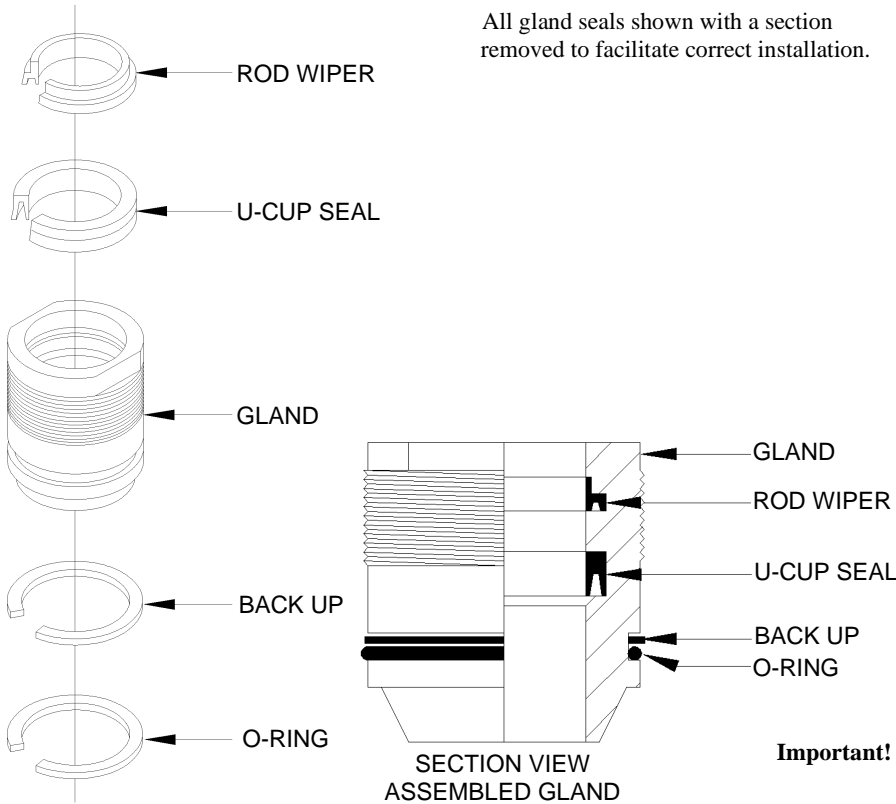

All gland seals shown with a section removed to facilitate correct installation.

Note: To install rod wiper and U-cup seal, fold similar to shape shown below, slip into gland bore and locate each in its respective groove. Tools are used to fold seals, take care not to damage sealing surfaces.

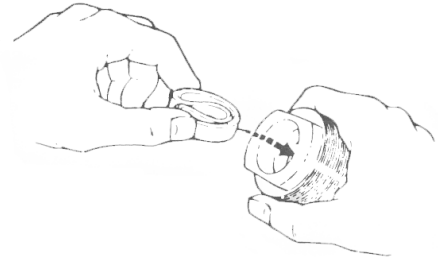

Important! Be sure all gland and piston seals have been installed correctly before cylinder is assembled!

CYLINDER PISTON SERVICE DIAGRAM

To Remove Seals:

Carefully cut across each seal with a sharp knife. Be sure not to scratch sealing surfaces of aluminum piston. If a sharp knife is not available. An electric soldering gun or hot iron may be used to melt throughout seals.

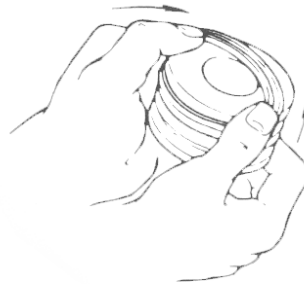
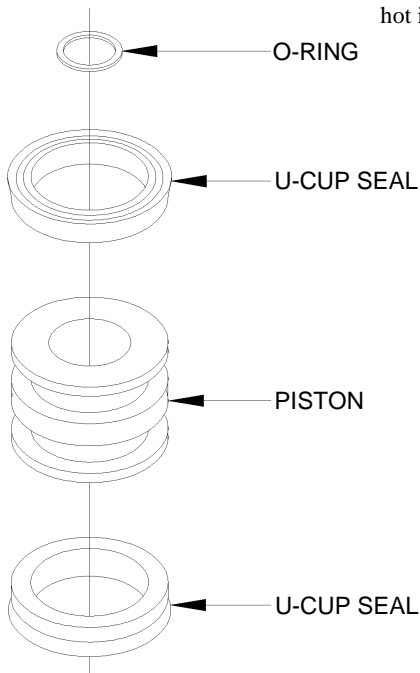

To Install Seals:

1. Thoroughly clean piston sealing surface of all foreign matter.
2. Heat new seals in hydraulic oil to 160° F. Never use a direct flame or heated water on hydraulic seals.
3. Remove seals from oil, wipe dry and install in piston grooves as shown in illustration at left. Be sure seals have completely seated in piston grooves before allowed to cool.
4. Replace piston on cylinder shaft and assemble cylinder when seals have cooled to room temperature.

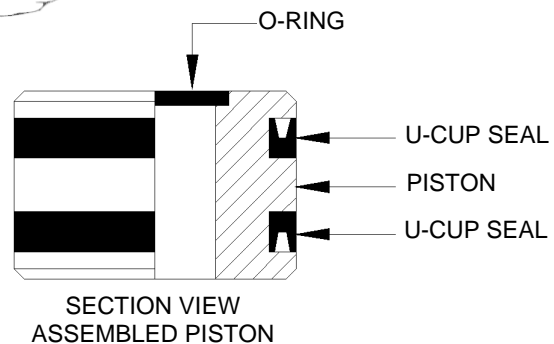

DINOIL VALVE HOOKUP

NOTE: Valve normally shipped open center. Part No. #673010 W/Joystick

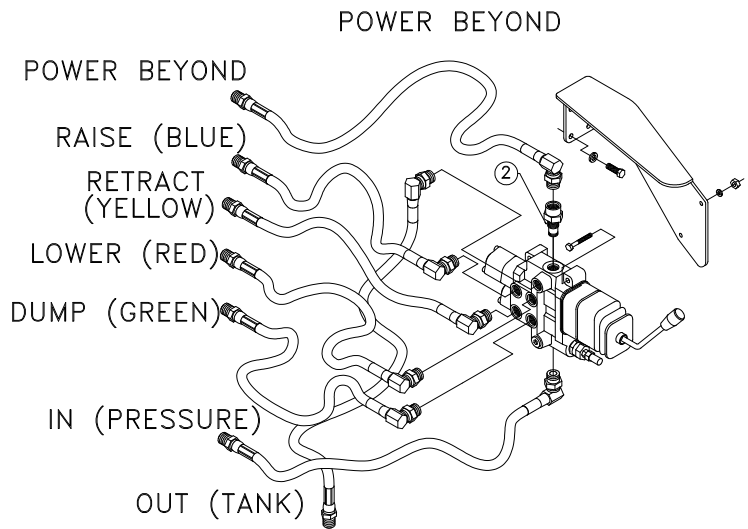

For closed center applications item one (655445) is replaced by item two (673097) and item one is installed in item two.

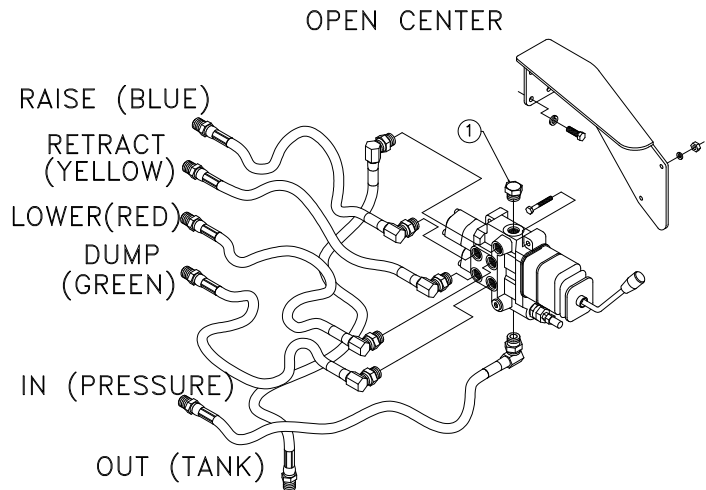

For power beyond applications item one (673096) plug, must be removed and item two (673097) power beyond sleeve must be added.

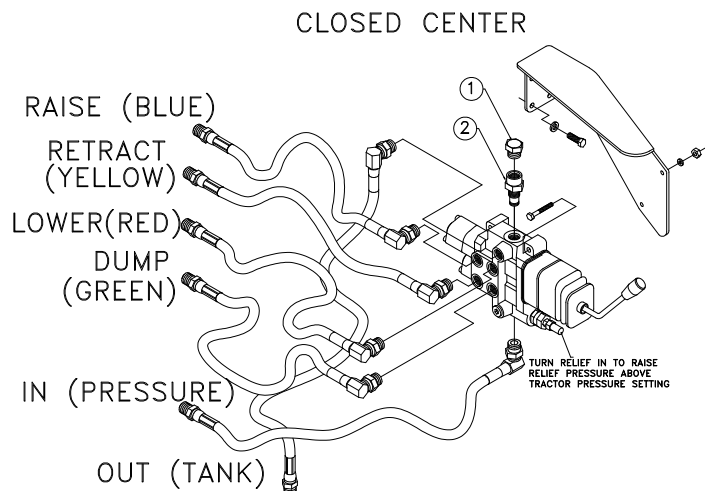

LIMITED WARRANTY

Thank you for purchasing a quality product from Koyker Manufacturing Company (Koyker). Your satisfaction with Koyker's products is very important to us. This manual will help you understand the function, service intervals, and warranty of your new Koyker product(s). It is the retail customer's responsibility to inspect the Koyker product(s) or part(s) before using. Before operating or allowing anyone to operate a Koyker product, please take time to read the manual thoroughly. Failure to do so may result in injury or death and is considered misuse. If your manual has been lost or destroyed, please contact Koyker at (800) 456-1107 or (605) 647-2811 for a new copy.

Koyker Manufacturing Company **Limited Warranty**

Koyker warrants to the retail customer of any new Koyker product, purchased from an authorized Koyker dealer, that the product manufactured by Koyker is free from defects in material and workmanship. This warranty is limited to one (1) year from the date of retail sale to the retail customer for all non-commercial, state, county, or city use. A six (6) month period from the date of retail sale to the retail customer is warranted for all commercial use.

Koyker reserves the right to inspect any products or parts which are claimed to be defective, have defective material, or have less than satisfactory workmanship before Koyker repairs or replaces any products or parts. A retail customer must notify Koyker of a claim by registered or certified mail, return receipt requested, within 30 days after discovery of a problem, or the claim shall be deemed waived. Defective products or parts must be returned to the Koyker factory, at the customer's expense, for inspection by Koyker. Koyker's obligation is limited to repairing or replacing, at its factory, any part or component it determines is defective. Koyker's replacement parts are manufactured with the same precision and skill as its original equipment. All warranted or replacement parts purchased or provided by Koyker will have, at a minimum, a 90-day warranty from the date of installation. If the expiration of the original warranty on a new Koyker product is longer than 90 days, the warranted parts will be covered until the original, new product warranty expiration date.

All cylinder claims shall be handled through Koyker's dealers or distributors. All hydraulic cylinders are thoroughly inspected before shipment from the Koyker factory. Therefore, no claim may be granted where a cylinder has been damaged or abused (including, but not limited to, bent tubes, dents, nicks, abused threads, attempted alterations, or welding), or unless the claim is made to Koyker within one (1) year from the sale to the original purchaser.

Any defective cylinder reported to Koyker within one (1) year from the sale by the dealer to the original purchaser may be repaired or replaced after Koyker's inspection and approval. In such case, notify a Koyker dealer for proper instructions. If after inspection, Koyker finds that the cylinder is not defective and has been abused or otherwise damaged, any transportation charges shall be paid by the original purchaser immediately after receiving notification of Koyker's inspection results.

LIMITED WARRANTY

Cylinders requiring factory repair more than one (1) year after sale to an original purchaser shall be given to a Koyker dealer for return to Koyker with transportation charges prepaid by the purchaser. The purchaser shall be responsible for all service and repair charges. Leaks around the shaft seal and internal bypass leaks may be field repaired. Service kits are available for those repairs.

Warranty Limitations and Exclusions.

THE WARRANTIES SET FORTH ABOVE ARE EXCLUSIVE AND ARE IN LIEU OF, AND PURCHASER HEREBY WAIVES, ALL OTHER CONDITIONS, REPRESENTATIONS AND WARRANTIES, EXPRESS OR IMPLIED BY STATUTE, USAGE, CUSTOM OF TRADE OR OTHERWISE, INCLUDING, WITHOUT LIMITATION, THE IMPLIED WARRANTIES OF MERCHANTABILITY AND FITNESS FOR A PARTICULAR PURPOSE. NOTWITHSTANDING ANY OTHER OR PRIOR STATEMENT, WRITTEN OR ORAL, KOYKER MAKES NO OTHER WARRANTIES REGARDING THE QUALITY OF THE PRODUCTS OR THE MATERIALS CONTEMPLATED HEREUNDER.

No warranty is given by Koyker for parts, components, or trade accessories furnished by Koyker but not manufactured by it. Those items are covered by the warranty of their manufacturer, if any. No person, firm, or corporation, including the selling dealer, is authorized to assume for Koyker any other liability in connection with the sale of these goods.

KOYKER SHALL NOT BE LIABLE FOR INDIRECT, SPECIAL, INCIDENTAL, CONSEQUENTIAL OR PUNITIVE DAMAGES DIRECTLY OR INDIRECTLY ARISING FROM THE DESIGN, CONSTRUCTION, INSTALLATION, MANUFACTURE, OR USE OF KOYKER'S PRODUCTS, PARTS, COMPONENTS, OR TRADE ACCESSORIES. Such incidental and consequential damages shall include, but not be limited to: non-associated taxes or duties; charges for normal maintenance or service; loss of crops, property damage, or any other income loss; freight charges, other than normal freight charges associated with Koyker products or parts; other installation charges not approved by Koyker; rental charges of any substitute equipment; expenses due to lost, damaged, or delayed products or parts resulting from acts beyond the control of Koyker; and personal injury or death of operator or bystanders by misappropriated use of Koyker products or parts.

A user shall notify Koyker in writing within 30 days of any accident or occurrence involving Koyker products resulting in personal injury or property damage and shall cooperate fully with Koyker in investigating and determining the cause of such accident or occurrence. In the event that a user fails to give such notice to Koyker and so cooperate, such user agrees to indemnify and hold Koyker harmless from all loss or damage arising from such accident or occurrence.

LIMITED WARRANTY

Among other conditions, Koyker's warranty will not apply:

1. Products or parts that are subject to misuse, abuse, and/or negligence.
2. For surface wear, scheduled maintenance parts, and other items that Koyker deems expendable.
3. If products or parts not manufactured by Koyker or approved by Koyker are connected to or used in conjunction with the Koyker products or parts and if Koyker deems the non-Koyker products or parts affect the performance, safety, reliability, or life of the Koyker products or parts.
4. If products or parts sold by, but not manufactured by Koyker, have their own vendor warranties.

Koyker reserves the right to implement new designs for the continual improvement of their products. These product improvements will be ongoing, and Koyker will not be responsible for incurring cost or obligation for installations or upgrades to previously sold products.

No employee or representative of Koyker may change or amend any part of this limited warranty or make exceptions to this limited warranty, unless such changes are made in writing by Koyker's legal counsel.

All goods being returned to the Koyker factory must have a Returned Goods Authorization (RGA) number from Koyker. To obtain an RGA number, call (800) 456-1107 or e-mail Koyker at koyker@koykermfg.com.

Returned parts will not be accepted without an RGA number written on the outside of the box of the returned goods. 30 days are allowed for shipping, from the day the RGA number was issued by Koyker. If the return item(s) is not received into the Koyker system within 30 days, no credit will be issued. Upon request only, a second RGA number will be issued and an additional 30 days may be allowed. No credit will be issued if the return item(s) are not received into the Koyker system 30 days after the second RGA number was issued.

Should you require additional information or assistance, please contact Koyker Manufacturing Company at (800) 456-1107, (605) 647-2811, or e-mail Koyker at koyker@koykermfg.com.

TORQUE SPECIFICATIONS

1. Tightening Bolts & Nuts

Check all loader bolts and nuts for tightness every 50 working hours. The movement of the loader over rough terrain may cause bolts to come under pressure and over a long period of time some slight stretching of the bolt may occur. The slack created may need to be taken up by tightening. Please refer below for recommended torque settings.

Metric Recommended Torque Settings

Size	Class 8.8				Class 10.9			
	Lubricated		Dry		Lubricated		Dry	
	N*m	Lb-ft	N*m	Lb-ft	N*m	Lb-ft	N*m	Lb-ft
M6.....	9	6.5	11	8.5.....	13	9.5	17	12
M8.....	22	16	28	20.....	32	24	40	30
M10.....	43	32	55	40.....	63	47	80	60
M12.....	75	55	95	70.....	110	80	140	105
M14.....	120	88	150	110.....	175	130	225	165
M16.....	190	140	240	175.....	275	200	350	225
M18.....	260	195	330	250.....	375	275	475	350
M20.....	375	275	475	350.....	530	400	675	500
M22.....	510	375	650	475.....	725	540	925	675
M24.....	650	475	825	600.....	925	675	1150	850
M27.....	950	700	1200	875.....	1350	1000	1700	1250
M30.....	1300	950	1650	1200.....	1850	1350	2300	1700
M33.....	1750	1300	2200	1650.....	2500	1850	3150	2350
M36.....	2250	1650	2850	2100.....	3200	2350	4050	3000

SAE Recommended Torque Settings

Size	Grade 5				Grade 8			
	Lubricated		Dry		Lubricated		Dry	
	N*m	Lb-ft	N*m	Lb-ft	N*m	Lb-ft	N*m	Lb-ft
1/4.....	9.5	7	12	9.....	13.5	10	17	12.5
5/16.....	20	15	25	18.....	28	21	35	26
3/8.....	35	26	44	33.....	50	36	63	46
7/16.....	55	41	70	52.....	80	58	100	75
1/2.....	85	63	110	80.....	120	90	150	115
9/16.....	125	90	155	115.....	175	130	225	160
5/8.....	170	125	215	160.....	215	160	300	225
3/4.....	300	225	375	280.....	425	310	550	400
7/8.....	490	360	625	450.....	700	500	875	650
1.....	725	540	925	675.....	1050	750	1300	975
1-1/8.....	900	675	1150	1200.....	2050	1500	2600	1950
1-3/8.....	1700	1250	2150	1550.....	2700	2000	3400	2550
1-1/2.....	2250	1650	2850	2100.....	3600	2650	4550	3350



DO NOT use these values if a different torque value or tightening procedure is given for a specific application. Torque values listed are for general use only and include a +/- 10% variance. Check tightness of fasteners periodically. DO NOT use air powered wrenches. Shear bolts are designed to fail under predetermined loads. Always replace shear bolts with identical grade.