

SIoux STEEL COMPANY

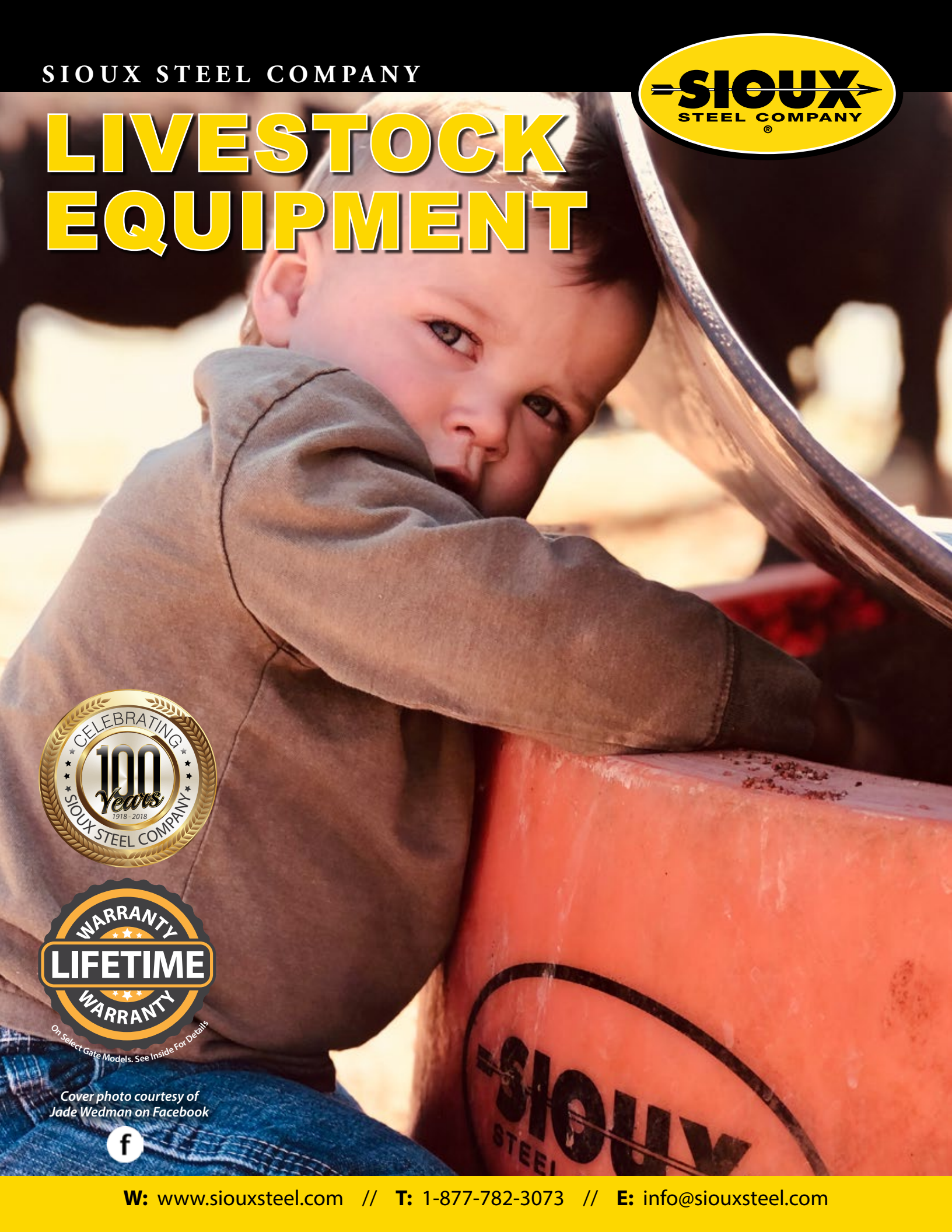

# LIVESTOCK EQUIPMENT



*On Select Gate Models. See Inside For Details*

*Cover photo courtesy of  
Jade Wedman on Facebook*





## LIVESTOCK EQUIPMENT

# SHIUX STEEL COMPANY ENGINEERING PRODUCTS FOR THE LIVESTOCK INDUSTRY

### SHIUX STEEL LIVESTOCK PRODUCT SPECIALISTS

With more years of experience than they would like to admit, our livestock specialists continue to develop relationships with ranchers across the country and the world.



**Tyler Madison**  
(Western US Sales Rep)



**Ty Dean**  
(SD, ND, KS & CO Sales Rep)



**Duane Kruse**  
(WI, IA, MN & MO Sales Rep)



**Brian D. Henley**  
(Eastern US Sales Rep)



**Beth Vacek**  
(Customer Engagement and  
ProTec Buildings/Livestock  
Sales Manager)



**Kelly Gillespie**  
(Engineering)



**Dan Tieszen**  
(Livestock Shipping)



**Chad Desy**  
(Livestock Shipping)



SIOUX STEEL PRODUCTS ARE  
**MADE IN THE USA**

Manufactured By A  
Family-Owned  
Company With A  
Century's Worth  
Of Experience

## The Equipment To Have

No other product can match our quality and durability, while offering the most common sense solutions for livestock equipment.

## Testimonial

*"I have been to several farm shows and watched the cattle chutes and tubs go head to head. For my family, we use the Sioux Steel chute, tub & alley system. Easy to use and durable, which are both very important. Lord willing, someday I'll pass down my name, and a Sioux Steel chute, tub & alley system."*

**Cord McCoy**  
Professional  
Bull Rider &  
Rancher



(Pictured with wife Sara)

*Livestock Management Solutions*

GATES . . . . .	4
PANELS . . . . .	10
FENCING . . . . .	14
FEEDERS . . . . .	16
WATERERS . . . . .	28
WORKING EQUIPMENT . . . . .	30

## Sioux Steel Heritage

Founded in 1918, Sioux Steel Company is now in its fourth generation as a family-owned company.

Our mission is not only to satisfy our customers, but we want them to be ***delighted*** to do business with us.

We feel a definite obligation to provide our customers with high-quality products and outstanding service.

# GATES

FEATURING MODELS WITH LIFETIME WARRANTIES

## VICTORY GATES

With heavy-duty Z-bar vertical braces, Victory gates are our heaviest and most durable line. Rounded tops and prairie gold powder coating make this one of our most popular livestock products and a must have on your farm or ranch.

VICTORY	GAUGE	LENGTHS	HEIGHT	BAR
<b>2" Victory Gate</b>	16	4' - 20'	50"	6
<b>1.5" Victory Gate</b>	16	4' - 18'	50"	6
<b>2" Hog Gate</b>	16	4' - 20'	38"	6
<b>2" Tall Gate</b>	16	4' - 18'	62"	7

**Color: Prairie Gold**

**Corners: Round Tops**

NOTE: Sioux Steel Victory Gates are sold less hinges. Order hinges separately. All specifications are subject to change or improvement without notice.

Actual gate lengths are 5" shorter than stated lengths.

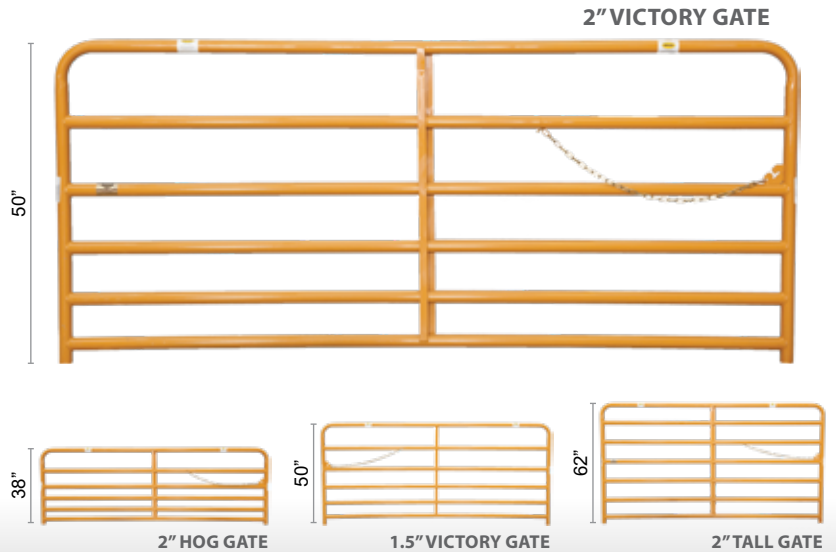

SIoux STEEL PRODUCTS ARE MADE IN THE USA



### LIFETIME WARRANTIES ARE STANDARD ON 2" VICTORY GATES & 2" VICTORY TALL GATES.

If a gate is ever damaged so that it cannot be used for its intended purpose, we will repair or replace at no charge.

Please See Additional Details On Page 6.

**16 GAUGE HIGH QUALITY MATERIALS**  
Made from 16 gauge, 58,000 psi, high-tensile structural steel tubing. Premium powder coat paint.

**Z-BAR VERTICAL BEAM**  
One piece formed and punched to support crossbars. All steel parts become one, unbroken piece. (except 4' & 6' gates)

**58,000 PSI 58,000 PSI**  
Sioux gates are made of high-tensile, 58,000 PSI structural steel tubing. (Does not include 1.5" Victory gates)

**MITERED JOINTS**  
Mitered and arc welded. Every tube is cut and tailored for a perfectly fitted connection before it's given a permanent, 360° weld.

**PATENTED T-SLOT LATCH & CHAIN**  
Slotted latch is easy to lock and unlock, but requires twisting action to open, so it's stock proof. Can be padlocked if needed. Chain is 29 links, 3 ft. long - wraps around railroad ties.

**DURABLE POWDER COATING**  
All Sioux Steel gates feature a powder coated finish in which premium paint is baked at high temperatures onto the metal of the gate, thus insuring a long-lasting protective barrier against the elements.



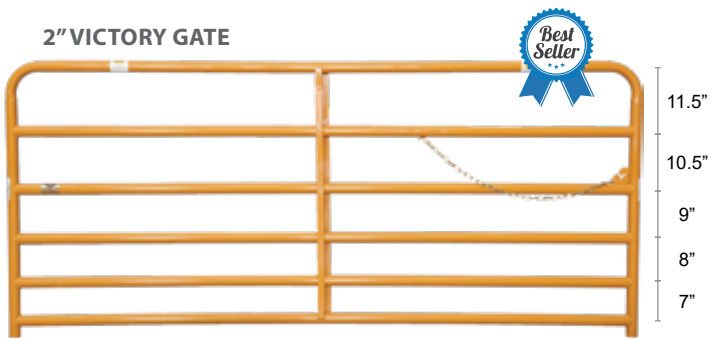

VICTORY 2" GATES	LENGTH	WEIGHT
SS450STKLH	4'	42 lbs.
SS650STKLH	6'	59 lbs.
SS850STKLH	8'	80 lbs.
SS1050STKLH	10'	97 lbs.
SS1250STKLH	12'	113 lbs.
SS1450STKLH	14'	134 lbs.
SS1650STKLH	16'	150 lbs.
SS1850STKLH	18'	171 lbs.
SS2050STKLH	20'	189 lbs.

**16** GAUGE | **6** BARS  
**50** INCHES HIGH

NOTE: Actual gate lengths are 5" shorter than stated lengths.

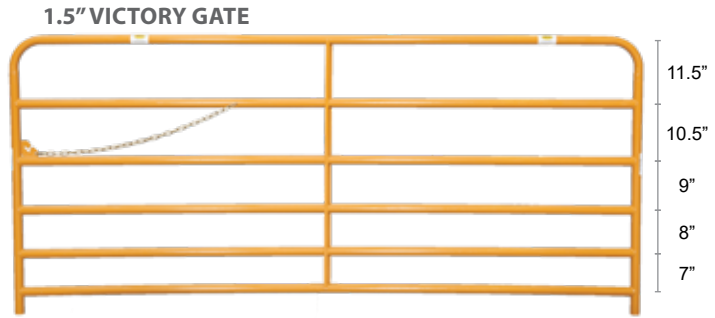

VICTORY 1.5" GATES	LENGTH	WEIGHT
SS450STK150LH	4'	30 lbs.
SS650STK150LH	6'	43 lbs.
SS850STK150LH	8'	57 lbs.
SS1050STK150LH	10'	69 lbs.
SS1250STK150LH	12'	81 lbs.
SS1450STK150LH	14'	96 lbs.
SS1650STK150LH	16'	108 lbs.
SS1850STK150LH	18'	123 lbs.

**16** GAUGE | **6** BARS  
**50** INCHES HIGH

NOTE: Actual gate lengths are 5" shorter than stated lengths. 50,000 PSI.

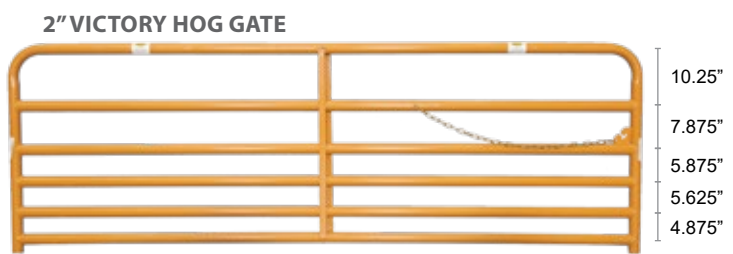

VICTORY HOG GATES	LENGTH	WEIGHT
SS438HOGLH	4'	36 lbs.
SS638HOGLH	6'	51 lbs.
SS838HOGLH	8'	70 lbs.
SS1038HOGLH	10'	86 lbs.
SS1238HOGLH	12'	106 lbs.
SS1438HOGLH	14'	122 lbs.
SS1638HOGLH	16'	144 lbs.
SS1838HOGLH	18'	163 lbs.
SS2038HOGLH	20'	190 lbs.

**16** GAUGE | **6** BARS  
**38** INCHES HIGH

NOTE: Actual gate lengths are 5" shorter than stated lengths.

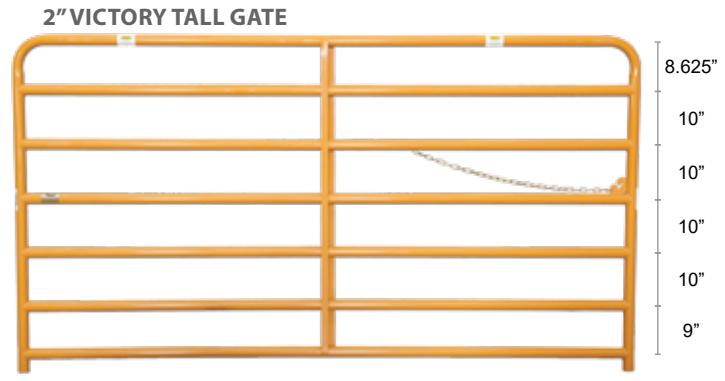

VICTORY 2" TALL GATES	LENGTH	WEIGHT
S164123	4'	46 lbs.
S164125	6'	82 lbs.
S164127	8'	106 lbs.
S164096	10'	114 lbs.
S162096	12'	136 lbs.
S162097	14'	164 lbs.
S162926	16'	186 lbs.
S179315PG	18'	199 lbs.

**16** GAUGE | **7** BARS  
**62** INCHES HIGH

NOTE: Actual gate lengths are 5" shorter than stated lengths.



WARRANTIES

## LIFETIME GUARANTEED GATES

- 2" Victory Gates
- 2" Victory Tall Gates
- 2" HiQual Heavy Duty
- 2" HiQual Cattleman's
- 2" HiQual Super Six

***We know our gates are tough and we want you to enjoy them for a lifetime!***

If a gate is ever damaged so that it cannot be used for its intended purpose, we will repair or replace at no charge to you, our customer. If a gate is hit with a loader or backed into with a truck/tractor, the gate has to be

damaged to the point that it cannot be used as a gate to hold cattle, sheep, hogs or any other livestock. This is not a scratch or dent cosmetic warranty, it's a pass or fail warranty as to the functionality of the gate.

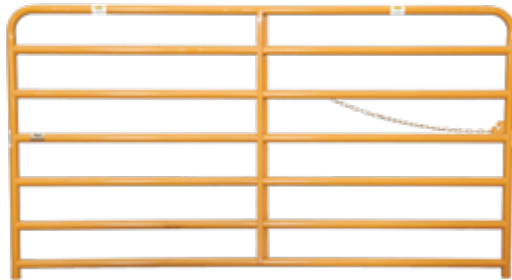

**2" VICTORY TALL GATE**

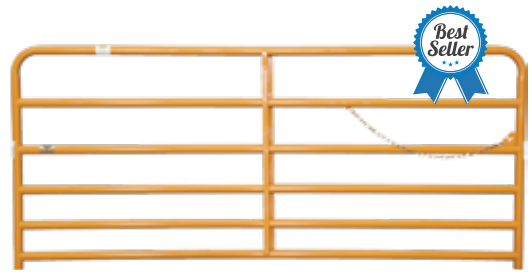

**2" VICTORY GATE**

Sioux Steel Company (the "Company") warrants to the original purchaser that the livestock gates labeled through the Company's "Lifetime Guarantee Gate Program" (the "Gates") are free from defects in material and workmanship for the life of the original purchaser. No individual or entity, including the selling dealer, is authorized to make any statements or assume for the Company any liability relating to or arising from the product or its use that varies from the express terms of the Limited Lifetime Warranty.

**EXCLUSIONS:** The Limited Lifetime Warranty does not cover and the Company is not responsible for: (i) modification or alteration of the Gates; (ii) cosmetic damage, normal wear and tear or damage that does not hinder the functionality of the Gates, including fading of the color; (iii) damage caused by use for purposes inconsistent with its intended purpose or design; (iv) damage due to use of any parts or components not supplied by the Company.

The obligation of the Company is limited to repairing or replacing at its factory any part or component determined to its satisfaction to be defective, and all costs, expenses including transportation, and any fees are the responsibility of the customer. The customer must notify the Company of a claim by registered or certified mail within (30) days after discovery or the claim shall be deemed waived at Sioux Steel Company, 196 1/2 E. 6th Street, Sioux Falls, SD 57104. This information is not intended to be the entire Limited Lifetime Warranty for the Gates and is for informational purposes only. Please see the Company's New Product Warranty for the full Limited Lifetime Warranty.



*Purchasing a Sioux Gate is like*  
**PLANTING A TREE...**

*You do it for the next*

**GENERATION**

Sioux Victory gates have been around a long time and with good reason. Families have continued to use these popular gates generation after generation.



# VICTORY 2" GATE TESTIMONIALS

"My cattle were recently TB tested. The bulls were last and the oldest one drove a young one into the gate corner. The gate held up. I was pretty impressed!"

*Thane M. Grove • Gladwin Tank Mfg., Inc.*

This 3 generation, family-owned operation owns an astounding 299 Sioux gates and panels. When asked why they buy Sioux gates, their answer was: "Strength, reliability, and their local dealer who cares about their operation."

*Steinheuser Farm • Tulare, SD*



"The Sioux gates my dad bought are now 45 years old. I won't have to replace them and I doubt my sons will either."

*Steve Mowry • Ma & Pa Angus*



*Tom LaFaive, retired ranch manager at Bad River Ranch in Ft. Pierre, SD., managed over 7,000 head of buffalo. The ranch has over 1,400 Sioux Steel Victory Gates on thousands of acres of land.*



**WATCH TOM'S STORY ON YOUR SMARTPHONE!**  
Scan The QR Code Above To Watch A Video Testimonial



# GATES

HIGH QUALITY GATES AND ACCESSORIES

## 2" GUARDIAN GATES

Sioux Steel Guardian Gates are higher quality, economy gates. They feature heavy-duty Z-bar vertical braces, round tops and patented t-slot latch with 36" chain. Powder coating creates a long-lasting barrier to the elements.

2" GUARDIAN GATE	GAUGE	HEIGHT	LENGTH	WEIGHT
SSR450GDNLH	18	50"	4'	33 lbs.
SSR650GDNLH	18	50"	6'	46 lbs.
SSR850GDNLH	18	50"	8'	63 lbs.
SSR1050GDNLH	18	50"	10'	75 lbs.
SSR1250GDNLH	18	50"	12'	88 lbs.
SSR1450GDNLH	18	50"	14'	105 lbs.
SSR1650GDNLH	18	50"	16'	118 lbs.
SSR1850GDNLH	18	50"	18'	134 lbs.

NOTE: Actual gate lengths are 5" shorter than stated lengths.



**Color: Red**  
**Corners: Round Tops**

NOTE: Sioux Steel Guardian Gates are sold less hinges. Order hinges separately. All specifications are subject to change or improvement without notice.

Actual gate lengths are 5" shorter than stated lengths.

**18** GAUGE | **6** BARS

**50** INCHES HIGH

**58,000** PSI

**18** GAUGE

POWDER COATED TOUGH



### SHOP ONLINE!

Search local dealerships or buy direct at [www.agpartsdirect.com](http://www.agpartsdirect.com). MSRP product pricing featured along with additional product information.

Fork Lift Gray	Desert Sand
Black Jet	White

### CUSTOM PRODUCT COLORS!

PLEASE CONTACT US FOR MORE INFORMATION.

Do you have a specific aesthetic idea for your farm or ranch? Need a custom color to create exactly what you have in mind? Sioux Steel Company offers custom product colors to fit your needs. Minimum order requirements.

## GATE & PANEL ACCESSORIES

Easily latch or unlatch gates while on horseback or on foot. Can be installed to wood or gate tubing. Versatile latch option for your operation.



GATE LATCH	DESCRIPTION	WEIGHT
SSRGLBRN	Rancher Gate Latch	7 lbs.

Another great option for a gate latch when on horseback. Heavy-duty with easy operation.

Fits horizontal gate bar spacing of 8 5/16" to 11 5/6".

**Height: 40.25"**  
**Width: 26"**

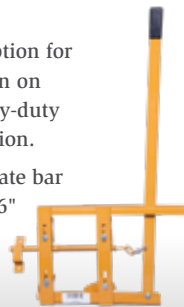

GATE LATCH	DESCRIPTION	WEIGHT
SSCBLPG	Cowboy Gate Latch	18 lbs.

These panel connector pins are used for adapting Sioux Steel & HiQual style connectors to range panels, alleys, squeeze chutes, etc. Pins are right hand and left hand, one of each is required for a connection point.

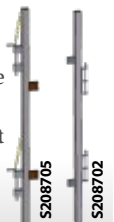

Available in Prairie Gold or HiQual Brown.

PANEL CONNECTOR PINS	DESCRIPTION	WEIGHT
S208705	LH Panel Connector Pin	7.1 lbs.
S208702	RH Panel Connector Pin	3.6 lbs.





## GATE ACCESSORIES



HEAVY DUTY HINGE	DESCRIPTION	WEIGHT
<b>S168760</b>	2" Adjustable Heavy Duty Plated Hinge	5.7 lbs.
<b>S174875</b>	Bucket Of (8) Hinges	49 lbs.

- Largest & heaviest hinge in the market.
- Heavy-duty hinge.
- 1" dia. x 12" threaded rod.
- 2 piece clamp with 1/2" hardware.



ADJUSTABLE HINGE	DESCRIPTION	WEIGHT
<b>S168750</b>	2" Adjustable Standard Plated Hinge	3.5 lbs.
<b>S172795</b>	Bucket Of (12) Hinges	45 lbs.

- Allows gate to be moved up or down.
- Takes tough wear. Swings 270°.
- 3/4" dia. x 12" threaded rod.
- 2 piece clamp and solid steel hinge pin.



J-BOLT W/ 2" CLAMP	DESCRIPTION	WEIGHT
<b>S173781</b>	Hinge Kit: J-Bolt w/2" Clamp Plated	3.2 lbs.
<b>S174874</b>	Bucket Of (12) Hinges	42 lbs.

- Adjustable in and out on bolt.
- Adjustable up and down on gate.
- 3/4" dia. x 12" threaded rod.
- 2" and 1 5/8" available.



J-BOLT W/ 1.5" CLAMP	DESCRIPTION	WEIGHT
<b>S228732</b>	Hinge Kit: J-Bolt w/1.5" Clamp Plated	2.7 lbs.
<b>S228765</b>	Bucket Of (12) Hinges	35 lbs.



LAG SCREW W/CLAMP	DESCRIPTION	WEIGHT
<b>S175191</b>	Hinge Kit- Lag Screw W/ 1.66" Clamp	1.2 lbs.
<b>S175182</b>	Bucket Of (24) Hinges	28 lbs.



WALL MOUNT	DESCRIPTION	WEIGHT
<b>S155755</b>	Hinge Kit - Wall Mount Bracket Plate is 4.5" x 4.5" x .25" thick. Plate to hinge center is 5.141".	3.3 lbs.

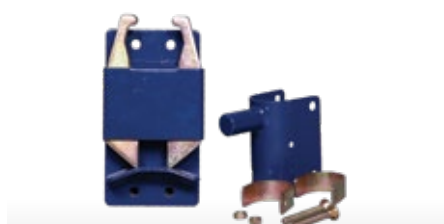

Fits round tube gates with a 1-5/8" - 2" outside diameter.

GATE LATCH	DESCRIPTION	WEIGHT
<b>SGL16103</b>	2-Way Gate Latch	4 lbs.



WHEEL KIT	DESCRIPTION	WEIGHT
<b>SGL16106</b>	8" Wheel Kit	3.5 lbs.

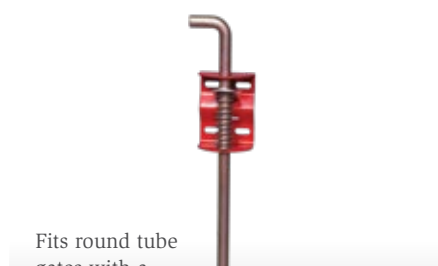

Fits round tube gates with a 1 3/4" - 2" outer diameter.

GATE ANCHOR	DESCRIPTION	WEIGHT
<b>SGL16102</b>	Gate Anchor	3.9 lbs.

# PANELS

STRONG, DEPENDABLE PANELS FOR YOUR LIVESTOCK NEEDS

## 1.5" VICTORY PANELS

Panels are prairie gold powder coated and feature round tops with Z-bar uprights and chain latch. Panels utilize 1.5" x 16 gauge, hi-tensile, 58,000 psi steel tubing making each panel extra durable.

1.5" VICTORY PANEL	GAUGE	HEIGHT	LENGTH	WEIGHT
SS1062CP2	16	62"	10'	77 lbs.
SS1262CP2	16	62"	12'	89 lbs.
SS1462CP2	16	62"	14'	105 lbs.
SS1662CP2	16	62"	16'	117 lbs.

Color: **Prairie Gold**

Corners: **Round Tops**

NOTE: All specifications are subject to change or improvement without notice. Contact Sioux Steel for information on delivery and fuel surcharges.

Actual panel lengths are 5" shorter than stated lengths.

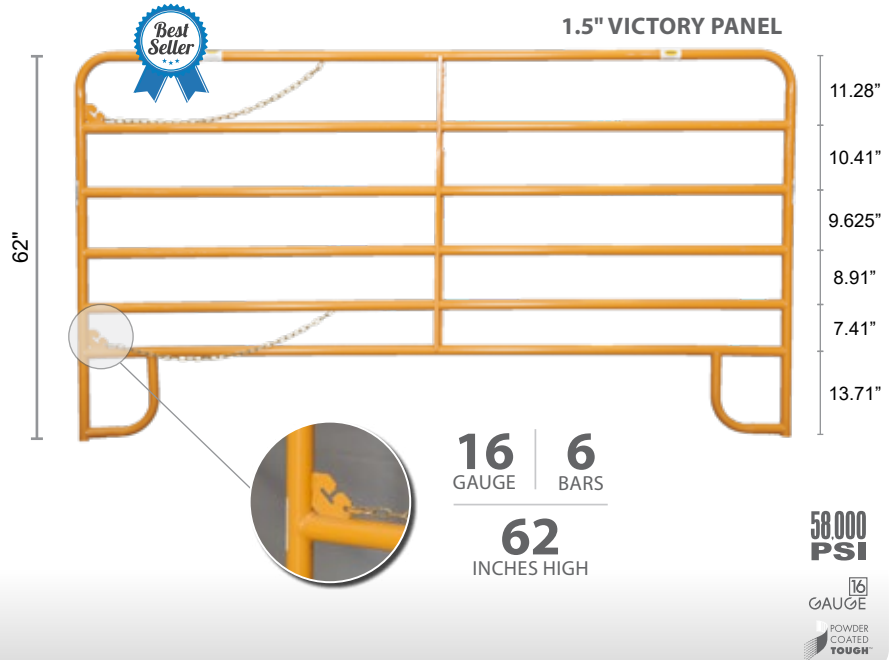

SIoux STEEL PRODUCTS ARE MADE IN THE USA

## VICTORY BOW GATES

Offering a 9' high clearance, these bow gates provide the perfect access to round pens, arenas and working corrals. Powder coated with a durable prairie gold finish, they withstand tough weather conditions.

VICTORY BOW GATES	LENGTH	DESCRIPTION	WEIGHT
SS4BG2	4'	4' Bow Gate w/Insert	64 lbs.
SS10CPBG2	10'	10' Panel w/4' Bow Gate & Insert	105 lbs.
S227896	6'	6' Bow Gate w/ Insert	86 lbs.
S227897	6'	6' Bow Gate w/ Insert and Cowboy Latch	96 lbs.

Color: **Prairie Gold**

Corners: **Round Tops**

Height: **9'**

NOTE: All specifications are subject to change or improvement without notice. Contact Sioux Steel for information on delivery and fuel surcharges.

Actual panel lengths are 4" shorter than stated lengths.

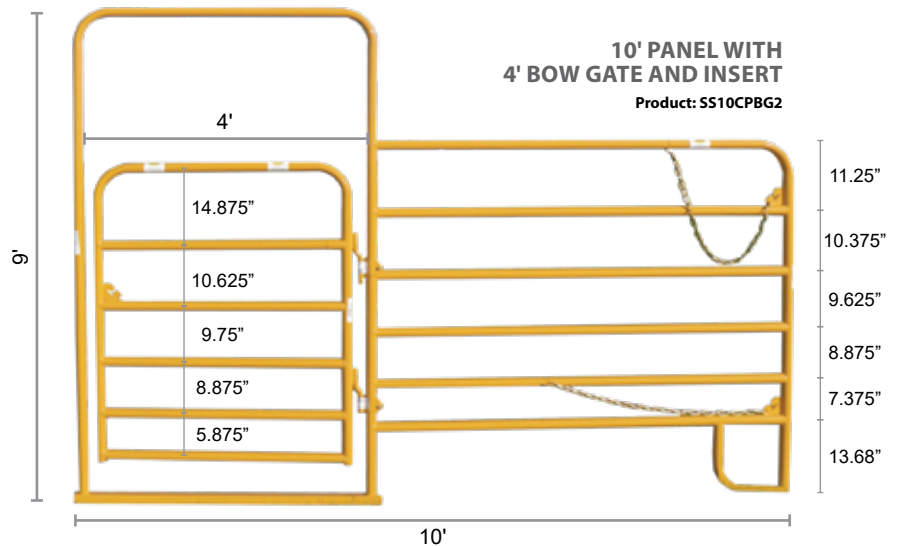

Product: SS4BG2

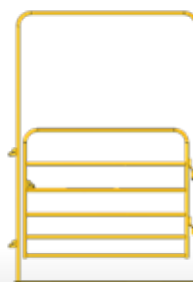

Product: S227896



Product: S227897





## 2" RANGE TOUGH PANELS

Designed to be connected directly to **Sioux Steel Working Equipment** (see page 34 for more Working Equipment), these heavy-duty corral panels can be easily transported and assembled right in the pasture.

Prairie gold powder coated and feature 2" x 16 gauge, hi-tensile, 58,000 psi steel tubing.

2" RANGE TOUGH PANELS	GAUGE	HEIGHT	LENGTH	WEIGHT
SS1072RT	16	72"	10'	103 lbs.
SS1272RT	16	72"	12'	119 lbs.
SS1472RT	16	72"	14'	139 lbs.
SS10RTBG6	10' Bow Gate w/4' Insert		140 lbs.	
SS12RTBG6	12' Bow Gate w/4' Insert		156 lbs.	

Color: **Prairie Gold**

Corners: **Square Tops**

NOTE: All specifications are subject to change or improvement without notice. Contact Sioux Steel for information on delivery and fuel surcharges.

Actual panel lengths are 5.25" shorter than stated lengths.

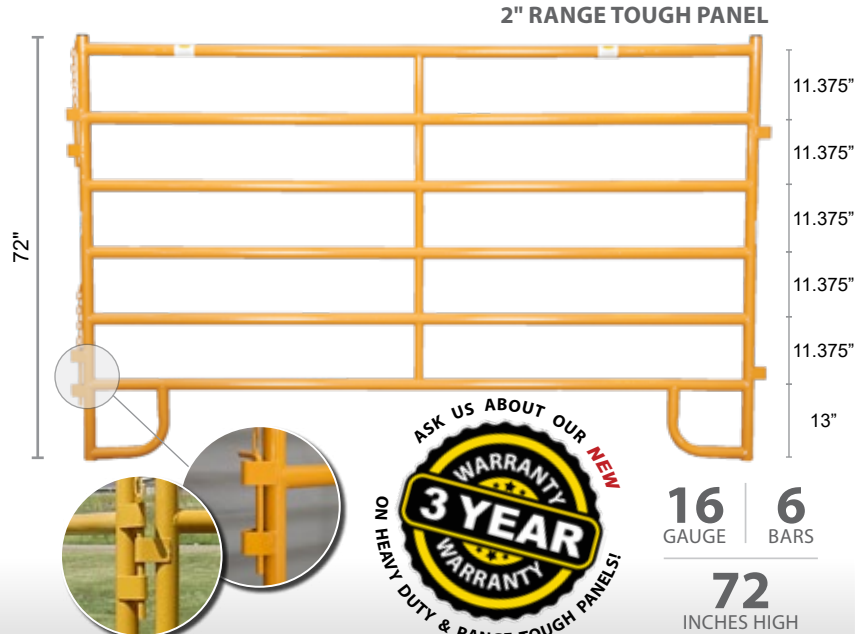

SIoux STEEL PRODUCTS ARE MADE IN THE USA

## VICTORY WALK-THRU GATES

Frame utilizes 2" x 16 gauge, hi-tensile, 58,000 psi steel square tubing. Swings gate is prairie gold 1.5" x 16 gauge powder coated and feature round tops with Z-bar uprights. Gate latches included.

2" WALK-THRU GATE	LENGTH	DESCRIPTION	WEIGHT
S227880	10'	Walk-Thru Gate w/10' Swing Gate	142 lbs.
S227881	12'	Walk-Thru Gate w/12' Swing Gate	161 lbs.

Color: **Prairie Gold**

Corners: **Square Tops**

Height: **7'**

NOTE: All specifications are subject to change or improvement without notice. Contact Sioux Steel for information on delivery and fuel surcharges.

Actual panel lengths are 2.5" shorter than stated lengths.

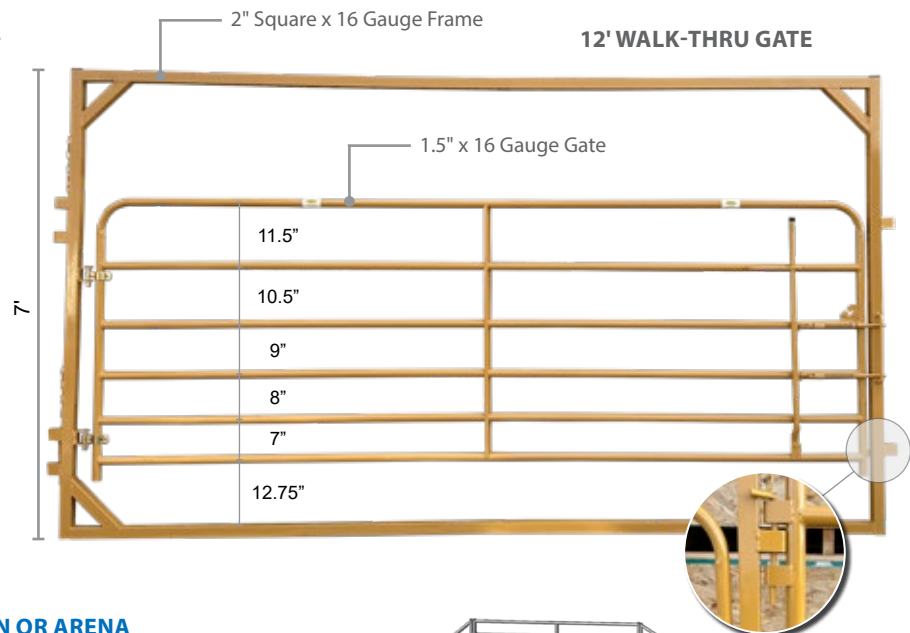

## CALCULATE PANELS NEEDED FOR YOUR CORRAL, PEN OR ARENA

	DIAMETER OF HOLDING AREA													
	20'	25'	30'	35'	40'	45'	50'	55'	60'	65'	70'	75'	80'	85'
10' Panels	6	8	9	11	13	14	16	17	19	20	22	24	25	27
12' Panels	5	7	8	9	10	12	13	14	15	16	18	20	21	22
16' Panels	4	5	6	7	8	9	10	11	12	13	14	15	16	17

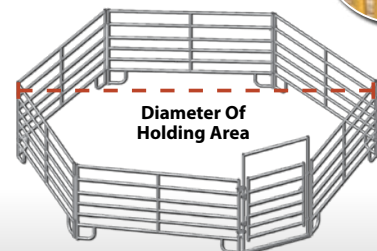

Circumference: The distance around the circle. Diameter: Straight line passing through the center of the circle.  
Calculate Number Of Panels Needed: Multiply the desired diameter by 3.14. Then divide by the length of the panels being used.



# PANELS

FROM MEDIUM DUTY TO FEEDER PANELS, WE HAVE IT ALL

## 1.5" MEDIUM DUTY PANELS

Panels are red powder coated and feature round tops with notched horizontals and chain latch. Panels utilize 1.5" x 16 gauge, hi-tensile, 50,000 psi steel tubing for medium duty applications.

Configure the number of panels needed by utilizing graphs on pages 13 or 15.

1.5" MEDIUM DUTY GUARDIAN PANEL	GAUGE	HEIGHT	LENGTH	WEIGHT
S191789RD	16	62"	10'	59 lbs.
S191789RD-12	16	62"	12'	64 lbs.

Color: Red

Corners: Round Tops

NOTE: All specifications are subject to change or improvement without notice. Contact Sioux Steel for information on delivery and fuel surcharges. Actual panel lengths are 5.375" shorter than stated lengths.

1.5" MEDIUM DUTY GUARDIAN PANEL

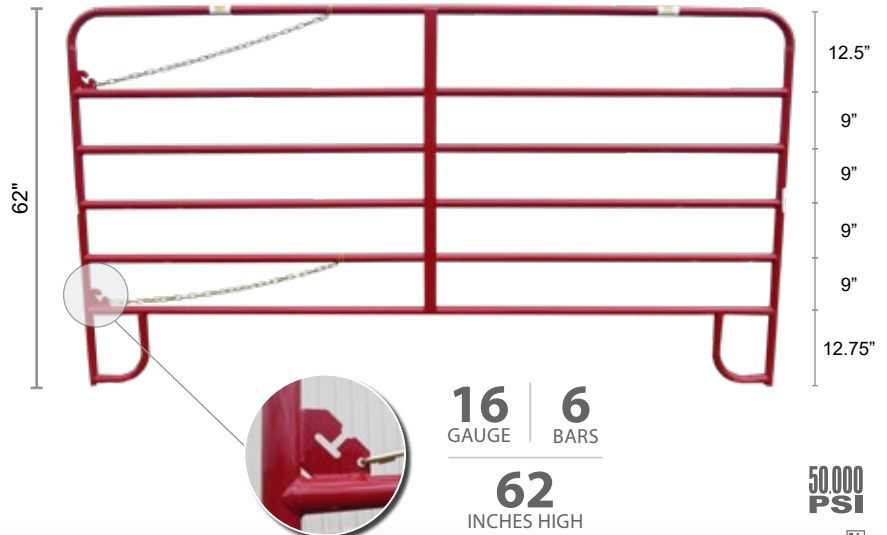

50,000 PSI  
16 GAUGE  
POWDER COATED TOUGH

SIoux STEEL PRODUCTS ARE MADE IN THE USA

## PANEL CART

Easily transport corral panels to your pastures with this Sioux Steel panel cart. Pens can be constructed right in the same field where cattle are located, allowing flexibility in your livestock operation.

PANEL CART	DESCRIPTION	WEIGHT
S230018	Prairie Gold Panel Cart (Spindle/Hubs)	750 lbs.
S230018BRN	HiQual Brown Panel Cart (Spindle/Hubs)	750 lbs.

Width: 7' 10" Length: 14' 6" Height: 91"

NOTE: All specifications are subject to change or improvement without notice. Contact Sioux Steel for information on delivery and fuel surcharges.

The panel cart features tires that are agriculture tires (ST225/75D15). Vehicles that has a 2" ball hook up can be utilized to pull the cart and panels to your destination.

A total of up to (40) 1.5" 10' or 12' panels/gates or up to (30) 2" 10' or 12' panels/gates can be hauled with the panel cart. The panel cart can carry 1,320 lbs in overall weight.

With the ability to easily transport up to 40 panels, you have the ability to assemble up to a 150' diameter round pen or multiple configurations right in the field of your choice, accommodating large and small jobs.

PANEL CART HAULS UP TO  
(40) 1.5" 10' or 12' panels/gates  
or (30) 2" 10' or 12' panels/gates

Product: S230018

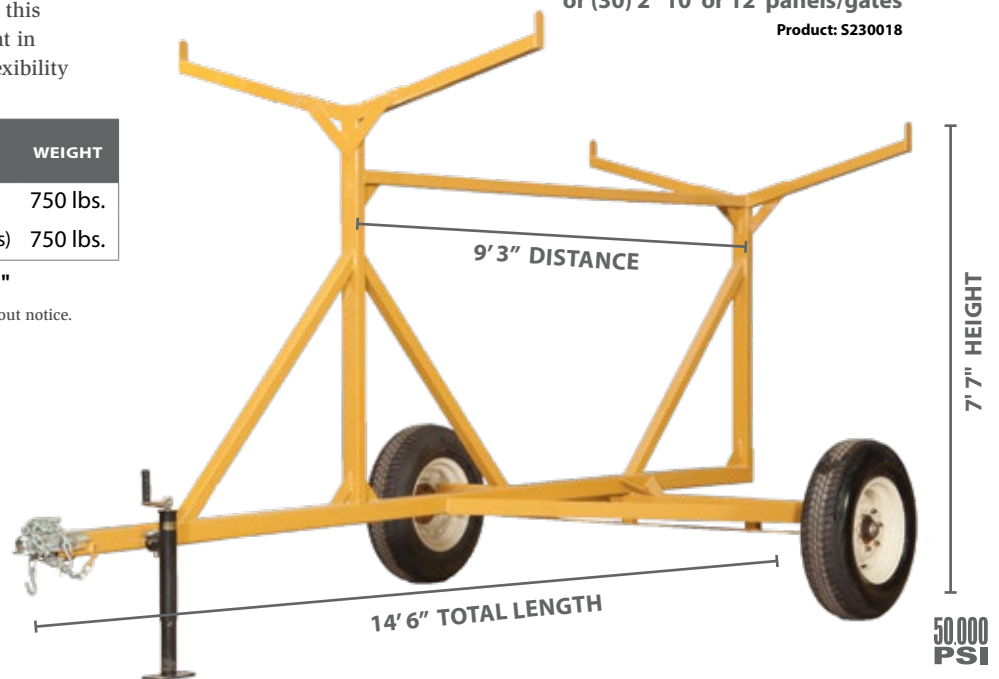

50,000 PSI  
16 GAUGE  
POWDER COATED TOUGH  
PORTABLE

### The Following Panels Can Be Utilized With The Panel Cart

- (10') 1.5" Victory Panel
- (12') 2" Range Touch Panel
- (10') 1.5" Medium Duty Panel
- (12') 1.5" Victory Panel
- (12') HiCountry HD Corral Panel
- (12') 1.5" Medium Duty Panel



## 2" Z-BAR FEEDER PANELS

Panels are prairie gold powder coated and feature round tops. Panels utilize 2" x 16 gauge, hi-tensile, 58,000 psi steel tubing. The Z slant bars with 16 gauge kick panel come with pin and loop connection points.

### Create a Square Bale Feeder:

Connect (2) 12' feeder panels and (2) 6' feeder panels together.

2" Z-BAR FEEDER PANELS	GAUGE	HEIGHT	LENGTH	WEIGHT
S227875	16	50"	4'	52 lbs.
S227876	16	50"	6'	68 lbs.
S227877	16	50"	8'	81 lbs.
S227878	16	50"	10'	98 lbs.
S227897	16	50"	12'	115 lbs.

Color: **Prairie Gold**

Corners: **Round Tops**

NOTE: All specifications are subject to change or improvement without notice. Contact Sioux Steel for information on delivery and fuel surcharges.

2" Z-BAR FEEDER PANELS

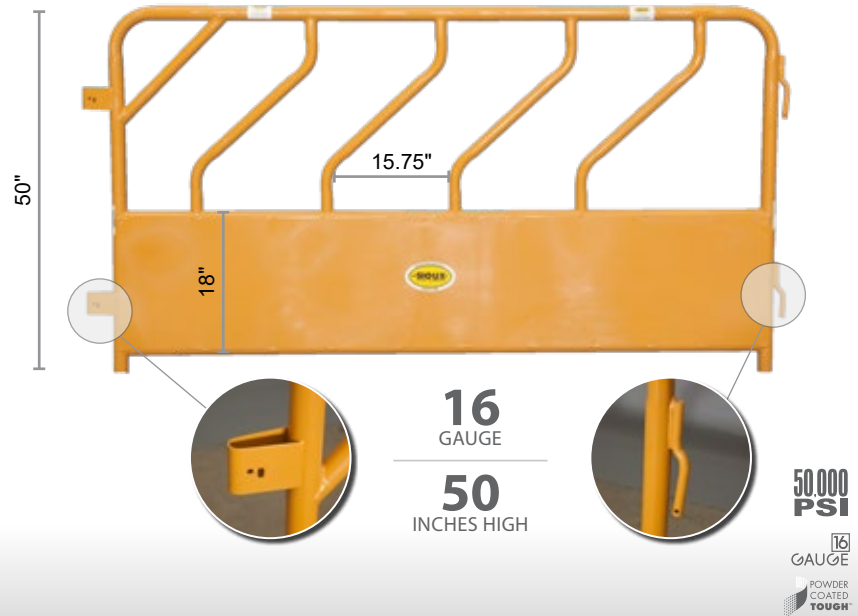

**58,000  
PSI**

### PANELS CONNECT TO WORKING EQUIPMENT

2" Range Tough Panels feature 2" x 16 gauge, hi-tensile, 58,000 psi steel tubing. Create a staging area for cattle before entering or after leaving working equipment. See page 11 for additional features.



# FENCING

STRONG AND ATTRACTIVE FENCING OPTION

## 10' FENCE PANELS

Heavy enough for working facilities, attractive enough for decorative fence. Panels are 16 gauge with square top with notched uprights.

10' FENCE PANELS	DESCRIPTION	HEIGHT	WEIGHT
S203699BRN	1.5" diameter w/4 rails	36"	46 lbs.
S180127BRN	1.5" diameter w/5 rails	48"	58 lbs.
S179388BRN	2" diameter w/5 rails	50"	75 lbs.
S179389BRN	2" diameter w/6 rails	62"	91 lbs.
S180270BRN	<b>Kit:</b> 1.5" Mounting Hardware		2 lbs.
S168241BRN	<b>Kit:</b> 2" Mounting Hardware		3 lbs.

**Color: Brown (Standard)    Corners: Square**

NOTE: All specifications are subject to change or improvement without notice. Contact Sioux Steel for information on delivery and fuel surcharges.

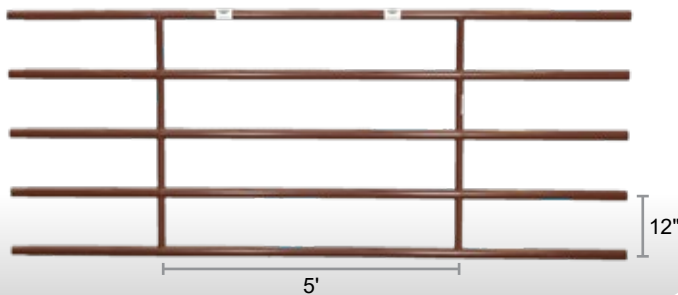

## 20' FENCE PANELS

Brown powder coated (standard). Other optional colors available. Panels are 16 gauge with square top with notched uprights.

20' FENCE PANELS	DESCRIPTION	HEIGHT	WEIGHT
S183687BRN	1.5" diameter w/4 rails	36"	80 lbs.
S180129BRN	1.5" diameter w/5 rails	48"	107 lbs.
S179390BRN	2" diameter w/5 rails	50"	149 lbs.
S179391BRN	2" diameter w/6 rails	62"	179 lbs.
S180270BRN	<b>Kit:</b> 1.5" Mounting Hardware		2 lbs.
S168241BRN	<b>Kit:</b> 2" Mounting Hardware		3 lbs.

**Color: Brown (Standard)    Corners: Square**

NOTE: All specifications are subject to change or improvement without notice. Contact Sioux Steel for information on delivery and fuel surcharges.

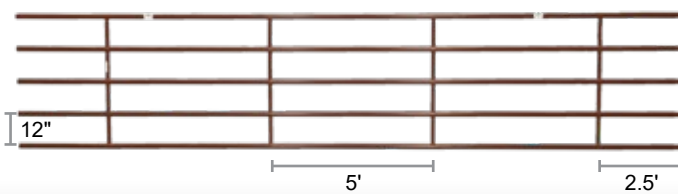

NOTE: 12" vertical spacing is the same for 1.5" and 2" on both 5 rail and 6 rail continuous fence options.

## PANEL ENDS

Panels have one end that is swaged to allow it to fit into the next panel for a solid joint. Non-swaged options are available.



FENCE PANEL ENDS	DESCRIPTION	WEIGHT
S183690BRN	1.5" 4 Rail Non Swaged	6 lbs.
S183689BRN	1.5" 4 Rail Swaged	7 lbs.
S179847BRN	1.5" 5 Rail Non Swaged	8 lbs.
S179845BRN	1.5" 5 Rail Swaged	9 lbs.
S180136BRN	2" 5 Rail Non Swaged	10 lbs.
S180135BRN	2" 5 Rail Swaged	11 lbs.
S180124BRN	2" 6 Rail Non Swaged	12 lbs.
S180120BRN	2" 6 Rail Swaged	14 lbs.

**Color: Brown (Standard)**

NOTE: All specifications are subject to change or improvement without notice. Contact Sioux Steel for information on delivery and fuel surcharges.

**Swaged**



**Non Swaged**



**PANEL END - 2" - 5 RAIL - NON SWAGED**

Product: S180136BRN

## CORNER MEMBER

45° or 90° corner members.  
"T" corner member options available upon request.

FENCE CORNER MEMBERS	DESCRIPTION	WEIGHT
S180137BRN	1.5" Tubing 90 Degrees	2 lbs.
S180139BRN	1.5" Tubing 45 Degrees	2 lbs.
S164078BRN	2" Tubing 90 Degrees	4 lbs.
S167493BRN	2" Tubing 45 Degrees	4 lbs.

S180270BRN	<b>Kit:</b> 1.5" Mounting Hardware	2 lbs.
S168241BRN	<b>Kit:</b> 2" Mounting Hardware	3 lbs.

**Color: Brown (Standard)**

NOTE: All specifications are subject to change or improvement without notice. Contact Sioux Steel for information on delivery and fuel surcharges.

### CORNER MEMBER - 2" TUBING - 90 DEGREES

Product: S164078BRN



**58,000 PSI**

**16 GAUGE**

**POWDER COATED TOUGH**



### CONTINUOUS FENCING

We own and operate a 2,300 acre farm. We looked at a lot of fencing products, but after comparing durability, quality and pricing, it was an easy choice. We put Sioux Steel's Continuous Fencing up ourselves. It was quick and easy to install.



Custom color options available for additional charge.  
Contact us for details.



White



Victory  
Prairie Gold

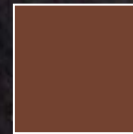

Brown



Guardian  
Red

# FENCING

*Continuous*

Connect With Us And Get The Latest Sioux Steel Product News And Updates  
Facebook • LinkedIn • YouTube • Twitter • Instagram



# FEEDERS

GET MORE FROM YOUR HAY FEEDER

## CLOSED BOTTOM FEEDER

Steel shield is welded to the frame allowing it to hold loose hay and silage. 1.5" x 16 gauge.

CLOSED BOTTOM HAY FEEDER	DESCRIPTION	WEIGHT
SSC83HF2	3 Piece System w/Slant Bars & Steel Lower Enclosure	204 lbs
S227325PG	1 Section Replacement	68 lbs.
S226340	Closed 8ft Haymax Top Section <i>(Add-on Option)</i>	254 lbs.

**Color: Prairie Gold Feed Openings: 15 Diameter: 8'**

NOTE: All specifications are subject to change or improvement without notice. Contact Sioux Steel for information on delivery and fuel surcharges.



50,000 PSI

16 GAUGE  
POWDER COATED TOUGH

SIoux STEEL PRODUCTS ARE MADE IN THE USA

## CLOSED BOTTOM HAY MAX

With 15 feed openings, the Closed Bottom Hay Max is the perfect solution for feeding livestock and getting the most out of your hay bales.

CLOSED BOTTOM HAY MAX	DESCRIPTION	WEIGHT
SSC83HFM2	Closed Bottom w/Bale Cradle	458 lbs.

**Color: Prairie Gold Feed Openings: 15 Diameter: 8'**

NOTE: All specifications are subject to change or improvement without notice. Contact Sioux Steel for information on delivery and fuel surcharges.

Hay Max Bale Cradle can not be ordered as stand alone piece. Sold as complete unit.

### Hay Max Bale Cradle

- 7 piece assembly
- 5' - 5" tall
- 18" x 20 gauge upper shield
- 16" diameter at bottom of base
- 1.5" x 16 gauge tube frame construction with 3 stabilizer bars
- 1.5" x 16 gauge cone tubes

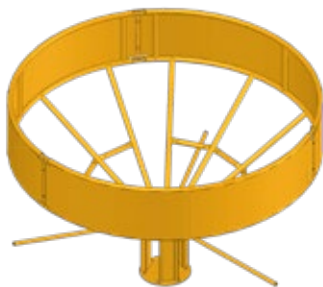

### Closed Bottom

- 3 piece assembly
- 3' - 9" tall
- 18" x 20 gauge lower shield
- 1.5" x 16 gauge tube frame construction
- 1" x 16 gauge cone tubes

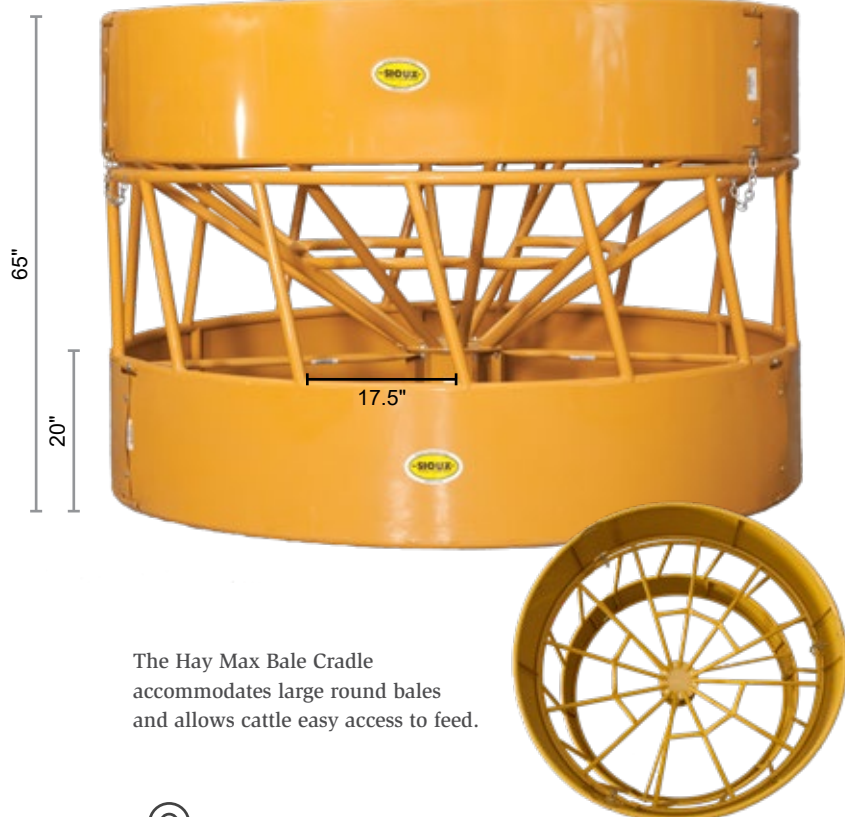
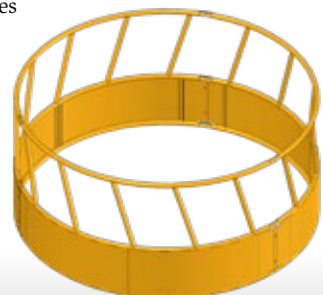

The Hay Max Bale Cradle accommodates large round bales and allows cattle easy access to feed.



**FIND YOUR LOCAL SIOUX LIVESTOCK DEALER**

Scan this QR code to search for the nearest livestock dealer in your area.



50,000 PSI

16 GAUGE  
POWDER COATED TOUGH





## CALF FEEDER

Used for small animals. Mid-level bar is 12" from the ground. Low enough to be used by lambs. 1.5" x 16 gauge frame.

CALF HAY FEEDER	DESCRIPTION	WEIGHT
SSC653HF2	3 Piece System With Slant Bars	108 lbs
S227814PG	1 Section Replacement	36 lbs.

**Color: Prairie Gold Feed Openings: 24 Diameter: 6.5'**

NOTE: All specifications are subject to change or improvement without notice. Contact Sioux Steel for information on delivery and fuel surcharges.

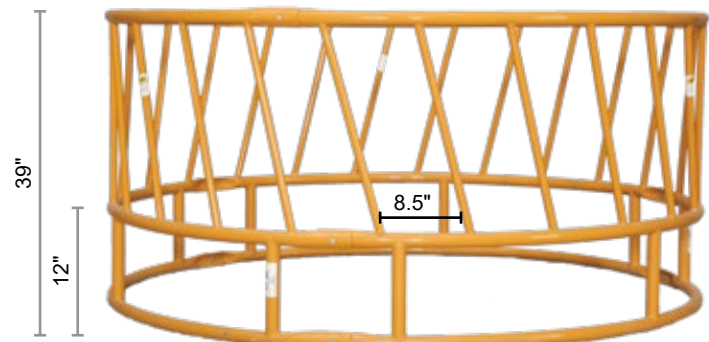

50,000 PSI

16 GAUGE  
POWDER COATED TOUGH

## OPEN BOTTOM FEEDER

Rounded 9" x 20" mud legs. **OPTION:** Polyethylene kick shield available to limit feed waste. 1.5" x 16 gauge frame.

OPEN BOTTOM HAY FEEDER	DESCRIPTION	WEIGHT
SSO83HF2	3 Piece System w/Slant Bars	135 lbs.
S13607	3 Piece Polyethylene Kick Shield	18 lbs.
S227320PG	1 Section Replacement	45 lbs.

**Color: Prairie Gold Feed Openings: 15 Diameter: 8'**

NOTE: All specifications are subject to change or improvement without notice. Contact Sioux Steel for information on delivery and fuel surcharges.

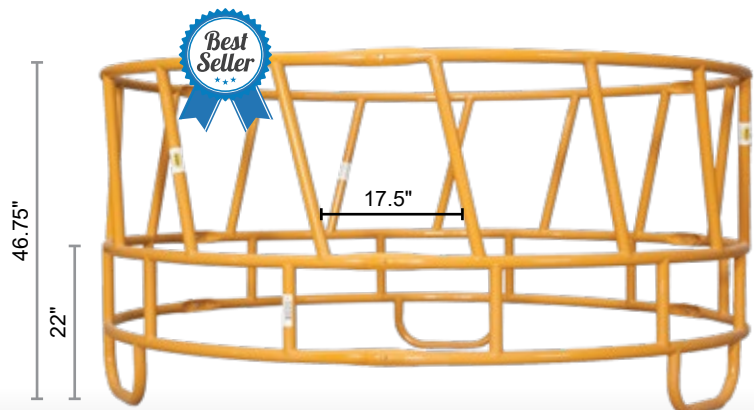

50,000 PSI

16 GAUGE  
POWDER COATED TOUGH

## DOUBLE SLANT FEEDER

This unique design allows the bale to be positioned upright as it is fed. 1.5" frame & 1.5" bars.

DOUBLE SLANT HAY FEEDER	DESCRIPTION	WEIGHT
SSDS83HF2	3 Piece System w/Slant Bars & Steel Lower Enclosure	228 lbs
S227343PG	1 Section Replacement	76 lbs.

**Color: Prairie Gold Feed Openings: 15 Diameter: 8' - 6.6'**

NOTE: All specifications are subject to change or improvement without notice. Contact Sioux Steel for information on delivery and fuel surcharges.



58,000 PSI

16 GAUGE  
POWDER COATED TOUGH

# FEEDERS

GET MORE FROM YOUR HAY FEEDER



## BULL FEEDER

Tapered top limits waste, but still accepts most bale sizes. Hay shield keeps feed in and calves out. 1.5" x 16 gauge frame.

BULL HAY FEEDER	DESCRIPTION	WEIGHT
SB853HF2	3 Piece System w/Slant Bars & Steel Lower Enclosure	282 lbs
S227816PG	1 Section Replacement	94 lbs.

**Color: Prairie Gold Feed Openings: 15 Diameter: 8.5'-7.2'**

NOTE: All specifications are subject to change or improvement without notice. Contact Sioux Steel for information on delivery and fuel surcharges.



SIoux STEEL PRODUCTS ARE MADE IN THE USA

## SQUARE BOTTOM HAY MAX

The Square Bottom Hay Max features 20 feed opening, accommodating a larger herd of cattle while saving you time.

SQUARE BOTTOM HAY MAX	DESCRIPTION	WEIGHT
SSQ754FR2	Square Feeder & Hay Cradle	686 lbs.
SSQ754HF2	Square (Bottom) Frame Only	376 lbs.
SSQ754HR2	Square (Top) Hay Cradle	310 lbs.

**Color: Prairie Gold Feed Openings: 20 Diagonal: 9.8'**

NOTE: All specifications are subject to change or improvement without notice. Contact Sioux Steel for information on delivery and fuel surcharges.

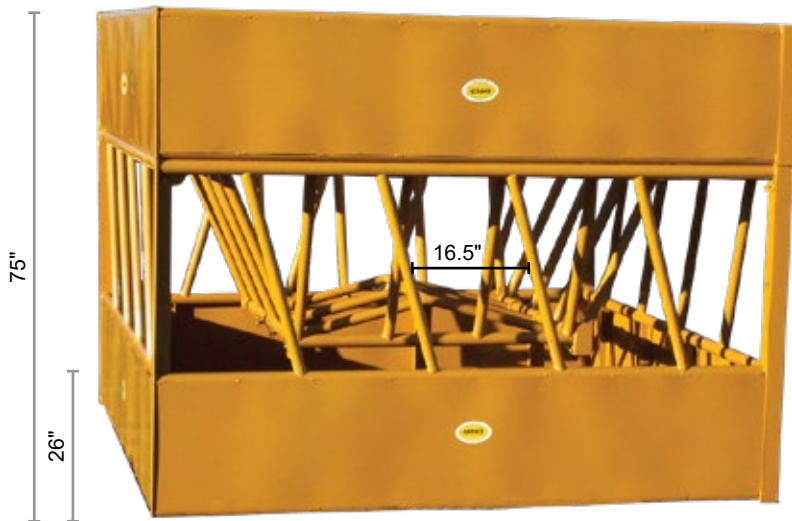

### Hay Max Bale Cradle

- 5 piece assembly
- 4' - 2.5" tall
- 7' - 7" square top
- 1.5" x 16 gauge tube frame construction
- 1.5" x 16 gauge cone tubes
- 18" x 20 gauge upper shield

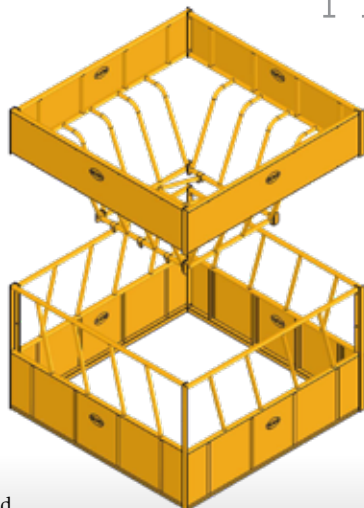

### Square Bottom

- 4 piece assembly
- 4' - 7" tall
- 7' - 7" square
- 1.5" x 16 gauge tube frame construction
- 1.5" x 16 gauge slant divider bars
- 24" tall x 20 gauge lower shield

### Square Feeder & Hay Cradle Assembly

- 6' - 3" overall height
- 18" x 20 gauge upper shields
- 7' - 7" square
- 26" x 20 gauge lower shields



### LIVESTOCK CUSTOMER SERVICE TEAM

Scan this QR code with your smartphone to call our livestock team today. Available 8am to 5pm, CST.



**Beth Vacek**  
(Customer Engagement and ProTec Buildings/Livestock Sales Manager)



Check Out The Difference!



**SAVE ON HAY EXPENSES**

With the Square Hay Max Feeder your hay doesn't end up on the ground...saving you time and money. The hay cradle easily contains large round or square bales while cattle feed from the one of twenty feed openings.

# HAY MAX

*Square Bottom*

Looking For A New Career Opportunity? Connect With Us To Learn More About Sioux Steel!  
Facebook • LinkedIn • YouTube • Twitter • Instagram • TikTok



# FEEDERS

GET MORE FROM YOUR HAY FEEDER



## CATTLE HAY/GRAIN FEEDER

Perfect for dairy or cattle operations and pasture feeding. Feed mineral, grain or silage with hay. Frame is 2" square 16 gauge tubing. Pan is 18 gauge. Unit measures 6.5' x 8'.

The Hay & Grain Feeder is designed and built so that hay falls past the first layer of bars down into the feeding pan. The end result is a savings of 1/4 to 1/2 of the hay bale. The frame is built entirely of square tubing and angle iron to give it strength. The feed pan withstands abuse as well as weather. The all welded design is built to last a lifetime.

CATTLE HAY/GRAIN FEEDER	DESCRIPTION	WEIGHT
SSCHGRNFDR	Hay & Grain Feeder	577 lbs.

**Color: Prairie Gold**    **Feed Openings: 12**    **Diagonal: 10.3'**  
**Length: 78"**    **Width: 96"**    **Height: 72"**

NOTE: All specifications are subject to change or improvement without notice. Contact Sioux Steel for information on delivery and fuel surcharges.



### Hay/Grain Feeder - Top View

If hay falls past the first layer of bars, it is captured in the lower level feeding pan.

Base Area of Upper Rack:  
**Width: 56"    Length: 37.625"**

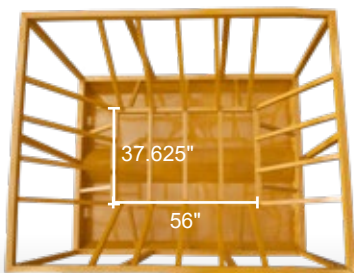

Scan This QR Code With Your Smartphone To Watch A Video!



**50,000 PSI**  
**16 GAUGE**  
 POWDER COATED TOUGH



## HORSE FEEDER

Rounded corners and all smooth edges protect horses' necks and manes. Fits most round or square bales. 1.5" x 16 gauge frame.

HORSE HAY FEEDER	DESCRIPTION	WEIGHT
SSH83HF2	3 Piece System With Steel Lower Enclosure	261 lbs
S227341PG	1 Section Replacement	87 lbs.

**Color: Prairie Gold**    **Feed Openings: 12**    **Diameter: 8'**

NOTE: All specifications are subject to change or improvement without notice. Contact Sioux Steel for information on delivery and fuel surcharges.



**50,000 PSI**  
**16 GAUGE**  
 POWDER COATED TOUGH



Save Hay and Money!



### STRONG HAY FEEDERS

Feeders are strong enough for the toughest cattle and transporting to and from different areas of your farm. With the Closed Bottom Hay Max Feeder hay falls back inside the feeder not on the ground when cows are feeding.

# HAY MAX

*Closed Bottom*

Be The First To See New Products And Watch Product Video Demos  
Facebook • LinkedIn • YouTube • Twitter • Instagram • TikTok



# FEEDERS

GET MORE FROM YOUR HAY FEEDER

## ROUND POLY FEEDER

Specifically designed for horse safety with overlapping joints & countersunk fasteners. Made from recycled materials with UV resistant resin.

ROUND POLY HAY FEEDER	DESCRIPTION	WEIGHT
FSPH84F	8' Round (4 Sections)	120 lbs.
F184933	1 Section & Hardware	20 lbs.

**Color: Yellow Poly**    **Diameter: 8'**

NOTE: All specifications are subject to change or improvement without notice. Contact Sioux Steel for information on delivery and fuel surcharges.



- Only 120 lbs.
- Lightweight and easy to assemble, move and transport.





## 5' FEED BUNK

The 5' Feed Bunk is shipped completely assembled and has a 335 lb capacity for livestock feeding. Hayrack is optional.

5' FEED BUNK	DESCRIPTION	WEIGHT
<b>S173953</b>	Bunk 5' Long x 20" Wide	60 lbs.
<b>S15549 (Optional)</b>	Hayrack 5' Long x 20" Wide	42 lbs.

**Color: Prairie Gold Feed Openings: 6 Length: 5'**

NOTE: All specifications are subject to change or improvement without notice. Contact Sioux Steel for information on delivery and fuel surcharges.



SIoux STEEL PRODUCTS ARE MADE IN THE USA

## 10' FEED BUNK

The 10' Feed Bunk is shipped completely assembled and has a 1/2 ton capacity for livestock feeding. With the optional hayrack the bunk feeder converts to hay feeder in minutes. Hayracks are made of 16 gauge, 50,000 psi steel tubing.

10' FEED BUNK	DESCRIPTION	WEIGHT
<b>S227882</b>	Bunk 10' Long x 24" Wide	118 lbs.
<b>S227883 (Optional)</b>	10' V-Rack Assembly	87 lbs.

**Color: Prairie Gold Feed Openings: 12 Length: 10'**

NOTE: All specifications are subject to change or improvement without notice. Contact Sioux Steel for information on delivery and fuel surcharges.



## 12' FEED BUNK

The 12' Feed Bunk is shipped completely assembled and has a 1 ton capacity for livestock feeding. Tubular steel frame is 16 gauge, 50,000 psi steel tubing. Dairy, feedlot and pasture use. Formed so bunks can be set end-to-end or stacked for storage.

12' FEED BUNK	DESCRIPTION	WEIGHT
<b>S227884</b>	Bunk 12' Long x 36" Wide	165 lbs.
<b>S227885 (Optional)</b>	Hayrack 12' Long x 36" Wide	89 lbs.

**Color: Prairie Gold Feed Openings: 14 Length: 12'**

NOTE: All specifications are subject to change or improvement without notice. Contact Sioux Steel for information on delivery and fuel surcharges.



# FEEDERS

GET MORE FROM YOUR HAY AND MINERAL FEEDER

## GROUND MINERAL FEEDER

The heaviest ground feeder available. Feeder is 15" high and 38" wide. 3 compartments allow for 200 LBS of mineral. Feeder can be anchored in 3 different locations for added stability. The low profile virtually eliminates tipping or spilling.

GROUND MINERAL FEEDER	DESCRIPTION	WEIGHT
S179218	Ground Mineral Feeder	64 lbs.
S198915	Replacement Flap Kit/Upgrade	24 lbs.

**Color: Orange**    **Compartments: 3**    **Total Height: 17"**

NOTE: All specifications are subject to change or improvement without notice.

\* Actual color may vary.



## LICK FEEDER

Feeder cap included. Concave base is grooved so lick wheels extract feed right from the bottom. Lick feeder is domed to prevent cattle from standing on top of equipment. Wheel brackets are raised to drain off rain or snow.

LICK FEEDER	DESCRIPTION	WEIGHT
SSLF280*	Lick Feeder with 2 lick wheels & mounting brackets	77 lbs.
SSLF280-4	Lick Feeder with 4 lick wheels & mounting brackets	84 lbs.
S175442*	24" Wheel Kit	4 lbs.

**Color: Orange**    **Capacity: 280 Gallons**    **Total Height: 38.5"**

**Bottom Diameter: 61"**

\* Actual color may vary.

### Features

- Made of high quality Polyethylene.
- Feedlot acids have no effect.
- Durable feeder cap.
- Heavy rib construction.
- Raised to drain off rain and snow.
- Assists natural feed clean out.
- Includes either 2 or 4 lick wheels and mounting brackets.



## UPRIGHT MINERAL FEEDER

Beveled hood opening is 28" x 24". Full 360° rotation protects expensive supplements from the elements. The newly designed 44" x 47" base frame footprint is built for strength and stability.

UPRIGHT MINERAL FEEDER	DESCRIPTION	WEIGHT
S229821	Poly Mineral Feeder - Powder Coated Base	92 lbs.
S230405GLV	Poly Mineral Feeder - Galvanized Base	92 lbs.
S229822BLK	Metal Base (Black) Only With Pivot	64 lbs.
S229822GLV	Metal Base (Galvanized) Only With Pivot	64 lbs.
S230404BLK	Metal Base (Black) Only Less Pivot	54 lbs.
S230404HGD	Metal Base (Galvanized) Only Less Pivot	54 lbs.
S171642	Kit - Dust Bag (Dust Insecticide)	3.6 lbs.
S164646	Dust Bag Replacement	0.5 lbs.
S168229	Kit - Poly Tip Tank (Oil Insecticide)	5 lbs.
S167887	Oiler Mop Replacement	0.9 lbs.







## HOG FEEDERS

SUPREME FEEDER	DESCRIPTION	WEIGHT
S142002	60 Bushel Complete, Hopper portion comes unassembled	335 lbs.
S142002-1	60 Bushel Complete with Hopper assembled to base	335 lbs.
S142702	60 Bushel (less lid), Hopper portion comes unassembled	265 lbs.
S142702-1	60 Bushel (less lid) with Hopper assembled to base	265 lbs.
S142802	60 Bushel (less bottom doors), Hopper portion comes unassembled	303 lbs.
S142802-1	60 Bushel (less bottom doors) with Hopper assembled to base	303 lbs.
S142902	60 Bushel (less lid & bottom doors), Hopper portion comes unassembled	281 lbs.
S142902-1	60 Bushel (less lid & bottom doors) with Hopper assembled to base	281 lbs.
S228723	Bottom - With Doors (no hardware or Hopper portion)	143 lbs.
S229715	Bottom - Less Doors (no hardware or Hopper portion)	122 lbs.



S16001

BIG 'O' FEEDER	DESCRIPTION	WEIGHT
S16006	40 Bushel Hog Feeder (complete)	312 lbs.
S16007	65 Bushel Hog Feeder (complete)	348 lbs.
S16008	90 Bushel Hog Feeder (complete)	383 lbs.

**Feed Openings: 12 (No Feed Doors) Rust Resistant**  
Includes poly base, trough/hopper, poly skirts, steel supports, galvanized sidewalls and poly cover.

### Parts, Add On Packages & Accessories

S16001	15 Bushel Poly Base	247 lbs.
S16088	40 Bushel (1 Row) - Base Add On	66 lbs.
S16089	65 Bushel (2 Row) - Base Add On	109 lbs.
S16090	90 Bushel (3 Row) - Base Add On	136 lbs.
S16023	25 Bushel Add Ring	37 lbs.
S16024	56" Cover (Poly Lid Package)	28 lbs.
S16072	Ladder Kit - 65 Bushel	11.5 lbs.
S16019	Ladder Kit - 90 Bushel	11.5 lbs.
S16034	Hardware Kit - Add Ring	2 lbs.

### Openings: 12 Feed Doors Diameter: 56.5 Inches

Advanced scalloped trough provides a "natural" opening contoured to the hogs jowl. Large head clearance allows the hog to adopt a comfortable stance and conduct eating motions inside the feeder. Keeps feed in the feeding zone where hogs can get to it.

### Features

- 12 large openings "natural" to hog anatomy.
- Long-lasting trough is heavy galvanized, 12 gauge steel.
- 60bu feeder is 75" tall with lid & 64.5" tall w/o lid.

## MINI FEED BIN

The average size home takes one 5 gallon bucket of corn for heat. That means that the mini corn bin will store enough corn to last 6 weeks. Using the mini corn bin to store corn for a corn-burning stove will save you money on fuel costs in the winter.

MINI FEED BIN	DESCRIPTION	WEIGHT
S186315	40 Bushel Mini Bin 5'x8' Tall	217 lbs.
S183678	65 Bushel Mini Bin 5'x10' Tall	325 lbs.

### Capacities: 40 & 65 Bushels

NOTE: All specifications are subject to change or improvement without notice. Contact Sioux Steel for information on delivery and fuel surcharges.

### Storage For

- Corn burning stoves
- Various grain pellets
- Bulk seed

### Features

- Unit comes with poly boot and slide valve for easy unloading of product in bin.
- Wide variety of bottom attachments.
- 40 bushel (5' x 8' tall) equals 2,240 lbs. capacity
- 65 bushel (5' x 10' tall) equals 3,640 lbs. capacity

SIoux STEEL PRODUCTS ARE MADE IN THE USA

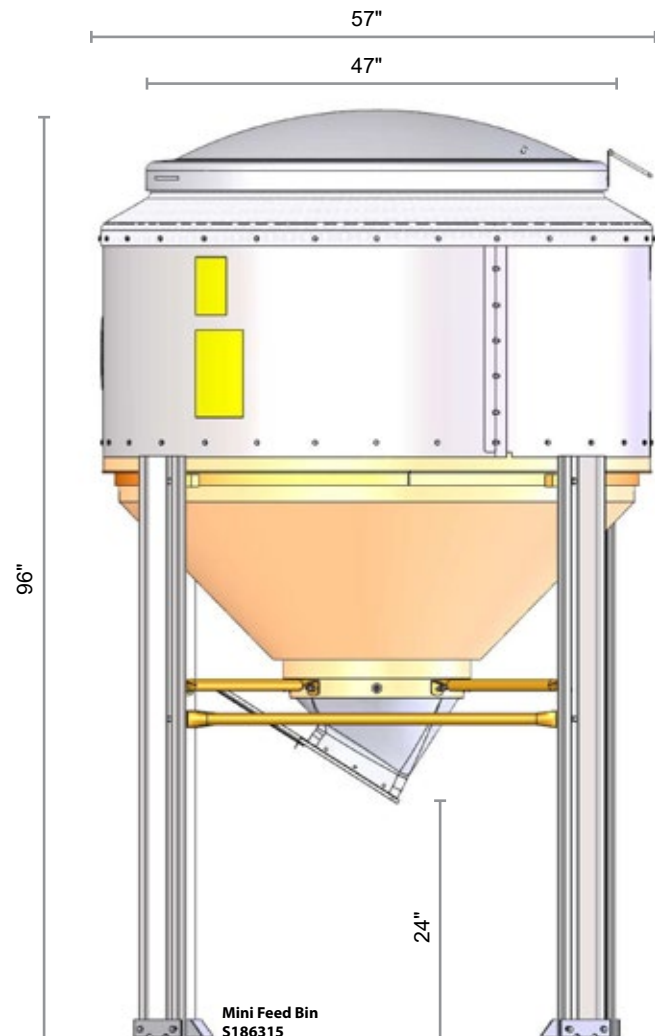

# FEEDERS

FEEDING AND STORAGE OPTIONS



## BULK FEED BINS

Available in 60° and 67° slopes in either a 16" or 22" hopper opening, Sioux Steel hopper panels are die-formed with rounded corners and down-turned sealing edges for safety and a weather-tight fit. Constructed using high tensile steel sidewall sheets with a G-90 commercial galvanized coating for outstanding strength and durability. Legs can be set to three different heights.

### 6' DIAMETER BIN

60° Hopper to 16" Opening with Collar & 4 Legs (30° Roof)

6' BULK FEED BINS	DESCRIP.	CAPACITY BUSHELS	CAPACITY U.S. TONS	CAPACITY CUBIC FEET	WEIGHT
SBFT616016	6' x 1 Row	111	2.76	138	456 lbs.
SBFT626016	6' x 2 Row	171	4.25	212	545 lbs.
SBFT636016	6' x 3 Row	231	5.74	287	654 lbs.
SBFT646016	6' x 4 Row	291	7.24	361	742 lbs.

### 7' DIAMETER BIN

67° Hopper to 16" Opening with Collar & 4 Legs (30° Roof)

7' BULK FEED BINS	DESCRIP.	CAPACITY BUSHELS	CAPACITY U.S. TONS	CAPACITY CUBIC FEET	WEIGHT
SBFT716716	7' x 1 Row	185	4.60	230	727 lbs.
SBFT726716	7' x 2 Row	266	6.63	331	854 lbs.
SBFT736716	7' x 3 Row	348	8.66	433	954 lbs.
SBFT746716	7' x 4 Row	430	10.96	534	1,079 lbs.
SBFT756716	7' x 5 Row	511	12.73	636	1,412 lbs.
SBFT766716	7' x 6 Row	593	14.76	737	1,622 lbs.



**BASIC BULK BINS INCLUDE:** Ground control fill cap (60° & 67° tanks through 15" dia.), roof panels, 2.66 corrugated sidewalls, 16" or 22" hopper opening (as indicated). 16" opening to include the appropriate hopper collar, while 16" opening tanks do not include hopper collar.

Capacities for 6'-9' diameter bins are calculated at 40lbs/cubic foot for free-flowing material. Bushels capacities for 6'-9' diameter bins are calculated with no compaction and to full cubic feet capacities.

### 9' DIAMETER BIN

60° Hopper to 16" Opening with Collar & 6 Legs (30° Roof)

9' BULK FEED BINS	DESCRIP.	CAPACITY BUSHELS	CAPACITY U.S. TONS	CAPACITY CUBIC FEET	WEIGHT
SBFT916016	9' x 1 Row	308	7.69	383	1,020 lbs.
SBFT926016	9' x 2 Row	443	11.04	551	1,151 lbs.
SBFT936016	9' x 3 Row	578	14.39	719	1,351 lbs.
SBFT946016	9' x 4 Row	713	17.75	887	1,546 lbs.
SBFT956016	9' x 5 Row	848	21.11	1055	1,776 lbs.
SBFT966016	9' x 6 Row	983	24.46	1223	2,218 lbs.

### 12' DIAMETER BIN

60° Hopper to 16" Opening with Collar & 8 Legs (30° Roof)

12' BULK FEED BINS	DESCRIP.	CAPACITY BUSHELS	CAPACITY U.S. TONS	CAPACITY CUBIC FEET	WEIGHT
SBFT1226016	12' x 2 Row	887	22.18	1109	2,491 lbs.
SBFT1236016	12' x 3 Row	1126	28.15	1407	2,666 lbs.
SBFT1246016	12' x 4 Row	1365	34.12	1706	2,889 lbs.
SBFT1256016	12' x 5 Row	1604	40.08	2004	3,256 lbs.
SBFT1266016	12' x 6 Row	1842	46.05	2302	3,882 lbs.

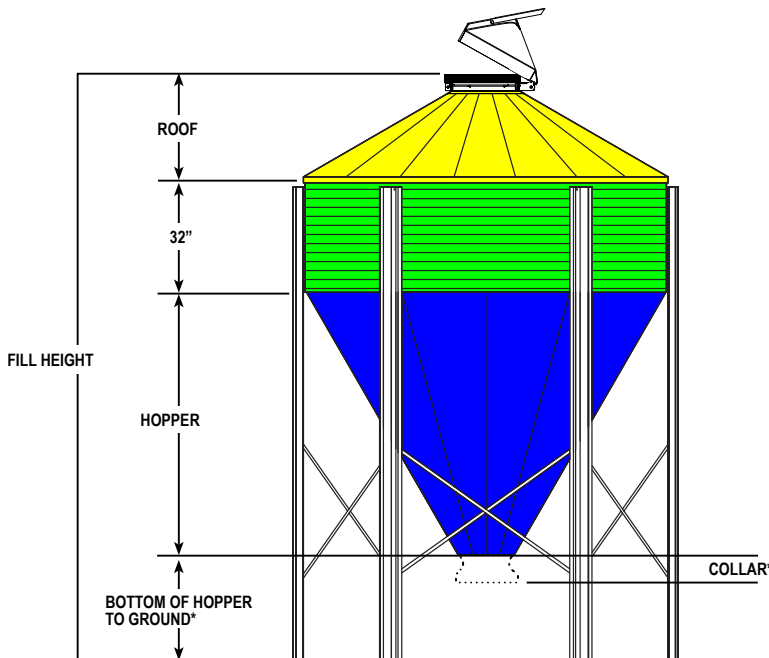

\*Note: Under collar clearance changes depending on the collar configuration.

### FILL HEIGHTS

BIN SIZE	1 RING	2 RINGS	3 RINGS	4 RINGS	5 RINGS	6 RINGS
6' 60°	129-1/16" (3278 mm)	161-1/16" (4090 mm)	193-1/16" (4903 mm)	225-1/16" (5716 mm)	N/A	N/A
7' 67°	163-3/4" (4159 mm)	195-3/4" (4972 mm)	227-3/4" (5784 mm)	259-3/4" (6597 mm)	291-3/4" (7410 mm)	323-3/4" (8223 mm)
9' 60°	170-11/16" (4335 mm)	202-11/16" (5148 mm)	234-11/16" (5961 mm)	266-11/16" (6773 mm)	298-11/16" (7586 mm)	330-11/16" (8399 mm)
12' 60°	NA	247-11/16" (6291 mm)	279-11/16" (7102 mm)	311-11/16" (7915 mm)	343-11/16" (8729 mm)	375-11/16" (9540 mm)



**Straight Boot**



**SFLX-2195**

**30° Poly Boot Black**

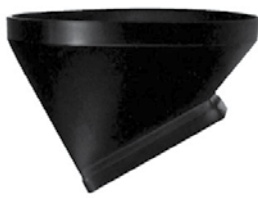

**SFLX-2194**

**30° Poly Boot Clear**



**SFLX-2194C**



**S15380 - Hopper Valve**



**Bin Lid**  
(Fits many brands of bulk feed bins)

OPTIONAL ACCESSORIES: Side ladders, cages, hopper stiffeners, bottom hopper gates, slide valves, poly boots, unloaders, augers & motors.

**Side Ladders**

<b>SBLK-13148</b>	6' x 1 Row	73 lbs.
<b>SBLK-13149</b>	6' x 2 Row	84 lbs.
<b>SBLK-13150</b>	6' x 3 Row	93 lbs.
<b>SBLK-13151</b>	6' x 4 Row	103 lbs.

<b>SBLK-13152</b>	7' x 1 Row	90 lbs.
<b>SBLK-13153</b>	7' x 2 Row	99 lbs.
<b>SBLK-13154</b>	7' x 3 Row	108 lbs.
<b>SBLK-13155</b>	7' x 4 Row	119 lbs.
<b>SBLK-13156</b>	7' x 5 Row	240 lbs.
<b>SBLK-13198</b>	7' x 6 Row	269 lbs.

<b>SBLK-13157</b>	9' x 1 Row	91 lbs.
<b>SBLK-13158</b>	9' x 2 Row	100 lbs.
<b>SBLK-13159</b>	9' x 3 Row	110 lbs.
<b>SBLK-13160</b>	9' x 4 Row	120 lbs.
<b>SBLK-13161</b>	9' x 5 Row	241 lbs.
<b>SBLK-13162</b>	9' x 6 Row	273 lbs.

<b>SBLK-13163</b>	12' X 2 Row	122 lbs.
<b>SBLK-13164</b>	12' X 3 Row	132 lbs.

Ladder packages include safety cage with ladder for all tanks with roof eave heights 20 ft and above.

All ladder parts and hardware are included in the ladder packages.

**Slide Valves, Poly Boots & Unloaders**

<b>SBLK-11879</b>	Hopper Valve Assembly for 6', 7', & 9' Bulk Bins (Manually installed by End User)	11 lbs.
<b>SBLK-11137H</b>	Transfer Plate & Slide Gate Kit 6"x10" W/ Hardware	
<b>SFLX-4854</b>	Sure-Flo Assembly 16" Hopper Opening	16 lbs.
<b>SFLX-2195</b>	Straight Black Plastic Boot 16"	6 lbs.
<b>SFLX-2194</b>	Plastic Boot 30 Degree - Black	5 lbs.
<b>SFLX-2194C</b>	Plastic Boot 30 Degree - Clear	5 lbs.
<b>SFLX-2196</b>	Plastic Boot Hardware Package 16"	0.5 lbs.
<b>SBLK-11137</b>	Transfer Plate & Slide Gate Kit 6" x 10"	4.5 lbs.
<b>S509500</b>	Collar Adapter 25.0 to 16.0	11 lbs.
<b>SRA-3036</b>	4" Rigid Unloader w/Stub Shaft & Bearing	19 lbs.
<b>SRA-30371</b>	6" Rigid Unloader w/ 1 5/8" Stub Shaft & Bearing	21 lbs.

**Augers For Poly Boot & Unloaders**

(Shown Less Motors)

<b>SGBF41100</b>	4" x 11' Utility Auger	71 lbs.
<b>SGBF41500</b>	4" x 15' Utility Auger	91 lbs.
<b>SGBF42000</b>	4" x 20' Utility Auger	114 lbs.
<b>SGCE45000</b>	5' Extension Tube & Flight- 4"	28 lbs.
<b>SGCE41000</b>	10' Extension Tube & Flight- 4"	54 lbs.
<b>SGCE42000</b>	20' Extension Tube & Flight- 4"	96 lbs.
<b>SGK2574</b>	90° 4" Spout, Top Section	3 lbs.
<b>SGK2578</b>	45° 4" Spout, Top Section	2 lbs.
<b>SGK1381</b>	2' Flex Tube w/ 90° 4" Spout	6 lbs.
<b>SGK1459</b>	4" Auger Support Brace	10 lbs.
<b>SGK3826</b>	4" Auger Support Band	4 lbs.
<b>SGBF6111A</b>	6" x 11' Utility Auger	173 lbs.
<b>SGBF6161A</b>	6" x 16' Utility Auger	212 lbs.
<b>SGBF6211A</b>	4" x 21' Utility Auger	251 lbs.
<b>SGCE65001</b>	5' Extension Tube & Flight- 6"	52 lbs.
<b>SGCE61001</b>	10' Extension Tube & Flight- 6"	91 lbs.
<b>SGK3407</b>	45° 6" Spout w/3' Flex Tube	13 lbs.
<b>SGK3416</b>	90° 6" Spout w/3' Flex Tube	13 lbs.
<b>SGK4807</b>	Custom Mount 6" x 2 Leg	14 lbs.
<b>SGK2834</b>	Bop: 6" Bulk Auger Support w/ Hardware	4 lbs.

**Motors For Augers (Less Pulley)**

<b>S154507</b>	.5 HP 1 PH Motor	41 lbs.
<b>S154510</b>	1.5 HP 1 PH Motor	48 lbs.
<b>S154614</b>	2 HP 1 PH Motor	83 lbs.
<b>S154616</b>	3 HP 1 PH Motor	104 lbs.
<b>S172446</b>	3.6 X .625 Bore Motor Pulley (6")	2 lbs.
<b>S154171</b>	2.5 X .625 Bore Motor Pulley (4")	.5 lbs.
<b>S171850</b>	3.6 X .875 Bore Motor Pulley (6")	2 lbs.
<b>S171851</b>	36" B' Section V-Belt (4" Auger)	1 lbs.
<b>S171852</b>	48" B' Section V-Belt (6" Auger)	1 lbs.



Plastic Boot Hardware must be ordered separately when not ordering unloader. Note: SBLK-11699 Slide Valve adapter plate is used to install 16" plastic boot under 16".

It is absolutely necessary to install an appropriate agitator in feed bins storing soybean meal, cotton seed meal, hot feeds, and other products not considered free-flowing material. All BFB series feed bins include the following standard features: Ground control fill cap, roof panels, 2.66 corrugated sidewalls, 16" hopper openings with collar.

# WATERERS

SMALL TO LARGE CAPACITY WATERERS AND TANKS



## UTILITY HOG WATERER

Big hogs drink with ease from 18" wide x 17" high x 9 fl" deep drinkers. Each drinker has a drain plug, so washing and flushing is fast, simple and complete. The float and valve are completely protected from hogs.

UTILITY HOG WATERER	DESCRIPTION	WEIGHT
<b>FSHW80</b>	80 Gallon Pig Waterer	41 lbs.
<b>S157187</b>	Replacement Valve Assembly	2 lbs.

ACCESSORIES	DESCRIPTION	WEIGHT
<b>SSTH10S</b>	1000 Watt Heater (Reservoir Submergible)	4 lbs.
<b>SSTH15C</b>	1500 Watt Heater - Convertible	4 lbs.
<b>S157209</b>	250 Watt Heater For Trough	4 lbs.
<b>S157206</b>	Automatic Water Valve	2 lbs.
<b>S157520</b>	Base Heater Cord Protector Kit	3 lbs.

**Capacity: 80 Gallons Drinking Areas: 2**

NOTE: Non-nesting charge. Poly stock tanks not nested are subject to a 5% charge for delivery. A "nest" is any two (2) tanks, one inside the other or single tank with a drinker.

NOTE: All specifications are subject to change or improvement without notice. Contact Sioux Steel for information on delivery and fuel surcharges.



### Features

- Trough height from floor is 6", so little pigs drink easily.
- One dependable float and valve handles both drinkers.
- 2 drinking areas.
- Drain plug for easy washing and flushing.



SIoux STEEL PRODUCTS ARE MADE IN THE USA



## BOTTOMLESS STOCK TANK

These tanks can compensate for the variable water output of windmill and solar panel systems, assuring an adequate supply of livestock water at all times.

BOTTOMLESS STOCK TANKS	SIZE	SECTIONS	CAPACITY (GAL)	WEIGHT
<b>SV1525BT</b>	15' x 25"	5	2,668	464 lbs.
<b>SV1533BT</b>	15' x 33"	5	3,544	630 lbs.
<b>SV1525BTL</b>	15' x 25"	5	2,668	614 lbs.
<b>SV1533BTL</b>	15' x 33"	5	3,544	723 lbs.

BT - Bottomless Tank Only BTL - Bottomless Tank With Liner

<b>SV2125BT</b>	21' x 25"	7	5,230	651 lbs.
<b>SV2133BT</b>	21' x 33"	7	6,948	880 lbs.
<b>SV2125BTL</b>	21' x 25"	7	5,230	873 lbs.
<b>SV2133BTL</b>	21' x 33"	7	6,948	1,111 lbs.

<b>SV2725BT</b>	27' x 25"	9	8,646	834 lbs.
<b>SV2733BT</b>	27' x 33"	9	11,486	1,131 lbs.
<b>SV2725BTL</b>	27' x 25"	9	8,646	1,149 lbs.
<b>SV2733BTL</b>	27' x 33"	9	11,486	1,455 lbs.

**Capacities: 2,668 - 11,486 Gallons**

NOTE: All specifications are subject to change or improvement without notice. Contact Sioux Steel for information on delivery and fuel surcharges.



- Livestock drink directly from bottomless tanks.
- Simple construction & easily adaptable to most sites.
- Large capacity at comparatively low cost compared with other tanks.
- Can be constructed with on-farm labor.
- Serves as both water storage and drinking device.

ACCESSORIES	DESCRIPTION	SIZE	WEIGHT
<b>S186709-5S</b>	Liner, Edge Protector & Trim Lock	15' x 25"	152 lbs.
<b>S186709-5TS</b>	Liner, Edge Protector & Trim Lock	15' x 33"	157 lbs.
<b>S186709-7S</b>	Liner, Edge Protector & Trim Lock	21' x 25"	232 lbs.
<b>S186709-7TS</b>	Liner, Edge Protector & Trim Lock	21' x 33"	238 lbs.
<b>S186709-9S</b>	Liner, Edge Protector & Trim Lock	27' x 25"	327 lbs.
<b>S186709-9TS</b>	Liner, Edge Protector & Trim Lock	27' x 33"	334 lbs.
<b>S186695A</b>	White PVC Clamps* (pictured above)		
<b>S199995</b>	Additional 5/8" Bolts With Washers		
<b>S154055</b>	Additional 5/8" Hex Nuts		

\* 15' tank requires 10 clamps • 21' tank needs 14 clamps • 27' tank needs 18 clamps





## ROUND END POLY TANKS

Safe for all livestock; hogs, pigs, cattle, horses in confinement, field, feedlot, or pasture. Hog drinkers can be installed.

ROUND END POLY TANK	DESCRIPTION	WEIGHT
<b>FPSRE224</b>	4' L x 2' W x 2' T 95 Gallon	26 lbs.
<b>FPSRE226</b>	6' L x 2' W x 2' T 150 Gallon	38 lbs.
<b>FPSRE224P</b>	4' L x 2' W x 2' T 95 Gal w/Drinker	40 lbs.
<b>FPSRE226P</b>	6' L x 2' W x 2' T 150 Gal w/Drinker	56 lbs.
<b>FPSRE215</b>	Sheep Tank 60 Gallon	16 lbs.
<b>S178239</b>	Cross Bar 4' or 6' Tanks - (1) 4' • (2) 6'	3 lbs.
<b>S15312</b>	Valve Kit - Round End Water Control	2 lbs.
<b>S156770</b>	Replacement Valve Assembly	0.3 lbs.
<b>F156638</b>	Hog Drinker - Complete Unit	17 lbs.



Product: FPSRE226P



POLY ethylene



**SHOP ONLINE! :: [www.agpartsdirect.com](http://www.agpartsdirect.com)**  
Search local dealerships or buy direct online.

## ROUND POLY TANKS

Stock tank that resists denting or cracking from the effects of weather, accidents or ill-tempered animals.

ROUND POLY TANK	DESCRIPTION	WEIGHT
<b>FPSR62</b>	6' Diameter x 2' Deep 335 Gallons	57 lbs.
<b>FPSR752</b>	7.5' Diameter x 2' Deep 530 Gallons	100 lbs.
<b>FPSR928</b>	9' Diameter x 28" Deep 950 Gallons	140 lbs.
<b>S156958</b>	Valve Kit - Round Tank Water Control	2 lbs.
<b>F160996</b>	Replacement Item -1.5" Plug	.1 lbs.

**Capacities: 335, 530 and 950 Gallons**

NOTE: Non-nesting charge. Poly stock tanks not nested are subject to a 5% charge for delivery. A "nest" is any two (2) tanks, one inside the other or single tank with a drinker.



Product: FPSR752



POLY ethylene



•.....**POLY TANK POOL**  
Can't find a pool online or in stores anywhere? We have a solution for you! Soak up the sun in a poly tank pool.



# EQUIPMENT

TAKING CARE OF YOUR CALVES WITH QUALITY EQUIPMENT



## CALVING PEN CARE SYSTEM

CALVING PEN	DESCRIPTION	WEIGHT
<b>S15503HD</b>	Calving Pen Care System	1094 lbs.
<b>S15503LH</b>	Calving Pen Care System Less Head Gate	842 lbs.
<b>S189756</b>	Head Gate Panel	163 lbs.
<b>S15506</b>	Standard Panel	163 lbs.
<b>S15505</b>	Nursing Panel	180 lbs.
<b>S173979</b>	7' Squeeze Gate	86 lbs.
<b>S15512</b>	Squeeze Gate Latch Package	29 lbs.
<b>S168700</b>	Anchor Mat	47 lbs.

### MOST USER-FRIENDLY CALVING PEN ON THE MARKET!

360° miter cut reinforcing corner members, 4x4 weld architecture and easy assembly connector clips eliminating nuts and bolts.

**S15503HD INCLUDES AUTO HEAD GATE & ANCHOR MAT!**



### WATCH A CALVING PEN VIDEO DEMONSTRATION

Scan this QR code with your smartphone to see how user-friendly this equipment is!



**Panel Sides**  
All four side panels open up and feature a slam-latch design.

#### System Includes:

- (1) 10' head gate panel
- (1) Auto head gate
- (1) Anchor mat
- (2) 10' standard panels
- (1) Squeeze gate ratchet latch
- (1) 7' squeeze gate
- (1) 10' nursing panel



**Product: S198400**

Learn more about the Sioux Steel Auto Head Gate on page 38.



#### Outside Flip-Up Nursing Panel

1/4 of the gate flips up and locks tight to provide open area on the outside of the pen for nursing, birthing, or veterinarian tasks.

#### Squeeze Gate

Tightens against outside panel to hold the animal secure and swings completely out of the way. Squeeze Gate converts to a 10'x10' pen for treating and holding sick or injured animals.



#### Swing Gate

Tough gold quality Sioux Steel gates made of 50,000 psi, 16 gauge, high-tensile steel tubing.



#### Inside Flip-Up Panel

1/4 of the gate flips up and locks tight to provide open area for easy, safe access to the animal for grafting calves to cows or for correcting nursing problems.



#### Ratchet Latch

Easy to handle and assures solid control of the animal. Tightens squeeze gate in increments. When locked, stays locked. Overhead rope gives quick, safe release.

#### Anchor Mat

Heavy 26.5" wide frame by 8' long, 9 gauge expandable steel mat with perimeter reinforcements. While animals stand with their feet on the mat, the mat does not allow the head gate or the pen to be pushed out of position.



**50,000 PSI**

**16 GAUGE**

POWDER COATED TOUGH



## CALF WARMER

The calf warmer creates a comfortable, enclosed environment for newborns during the critical hours after birth.

The heater is located in a separate enclosure at the rear of the calf warmer. The interior of the calf warmer provides enough room so the calf can lie down or stand. The instinctive identity scent will not be removed, so waiting mothers reclaim their rejuvenated infants at once.

5 year prorated warranty on the shell, 1 year warranty on the flooring and 6 month warranty on the heater.



CALF WARMER	DESCRIPTION	WEIGHT
S176314	Poly Calf Warmer w/Heater	150 lbs.
S177902	Calf Warmer Heater	6 lbs.

**Dimensions: 24" W x 50" L x 45" T**

**Lower Section: 16" Deep**

NOTE: All specifications are subject to change or improvement without notice. Contact Sioux Steel for information on delivery and fuel surcharges.

### Features

- Made from durable, medium density polyethylene
- Removable top section for easy cleaning
- Ribbed bottom
- Vent/Peep hole for proper ventilation and viewing
- Deluxe, high-performance, 110 volt, 2-speed heater



Photo courtesy of @ashlyb\_larsonfarms on Instagram



# EQUIPMENT

## CORNERLESS CROWDING TUB

Cattle feel safe and secure with the enclosed sides of the Sioux Cornerless Crowding Tub. Extra durable stamped side wall ribs give each wall of the tub extra strength. Tub is completely assembled at factory, except the catwalk.

SIoux STEEL PRODUCTS ARE MADE IN THE USA

CORNERLESS CROWDING TUB	DESCRIPTION	WEIGHT
<b>S191671</b>	Right Handed Crowded Tub	1,506 lbs.
<b>S198846</b>	Left Handed Crowding Tub	1,506 lbs.
<b>S196477PG</b>	Alley/Tub Filler Panel Spacer	53 lbs.

CORNERLESS CROWDING TUB	DESCRIPTION	WEIGHT
<b>S191671LCW</b>	RH Crowded Tub Less Catwalk	1,289 lbs.
<b>S198846LCW</b>	LH Crowded Tub Less Catwalk	1,289 lbs.

POWDER COATED TOUGH GAUGE 16 50,000 PSI

**Alley Tub Filler Panel Spacer**  
Product: S196477PG



16'

RIGHT HANDED OPERATION

### Features

- Extra large tub size & catwalk are both standard features.
- 4 separate doors allow for additional entry, exit and sorting capability.
- Multiple entries & exits.
- 2 separate ways for alley and chute alignment allowing for greater flexibility when configuring equipment.
- System sections are bolted together allowing replacement of parts versus entire system. This feature also allows the system to be broken down and moved if needed.
- Full catwalk comes standard with tub.
- Left or right hand options available.

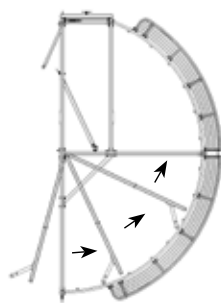

Right Handed Unit



6'

RIGHT HANDED OPERATION

### Specifications

- 8' cornerless tub.
- 16' total length.
- Bolted system.
- 6' high tubs sides.
- 2" square tubing construction around tub.
- Includes built-in vertical lift gate.

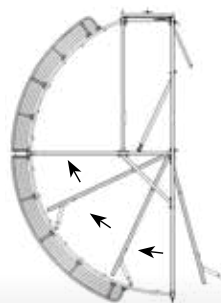

Left Handed Unit



LEFT HANDED OPERATION



W: [www.siouxsteel.com](http://www.siouxsteel.com) // T: 1-877-782-3073 // E: [info@siouxsteel.com](mailto:info@siouxsteel.com)



Enclosed Sides Make Cattle Feel Safe



Catwalk Around Tub



Sorting Door In Use



"We replaced all the gates with Sioux Steel gates and purchased a Sioux head gate/squeeze chute combination. We have worked the same cows with Sioux products and have been amazed at the difference. Numerous times we have had full grown cows try get out over these gates, and they did not buckle at all.

The head gate/squeeze chute combination has been nothing short of amazing. No cows have been injured and they are much safer for the operators. I highly recommend Sioux Steel gates and cattle handling equipment."

**Dr. Jim Gore • Gore Farms**

# CROWDING

## Cornerless Tub

Be The First To See New Products And Watch Product Video Demos  
Facebook • LinkedIn • YouTube • Twitter • Instagram • TikTok



# EQUIPMENT

## ALLEYS & IN-LINE GATES

### ADJUSTABLE ALLEYS

After leaving the tub, cattle naturally move toward the light by passing through these adjustable alleys, providing a smooth, continuous flow and reducing stress.

Alleys allow animals to be squeezed down to 16" for calves and out to 30" for mature animals with 6 locking points.

(2) 8 1/2' alleys can be linked together to create a 16' alley!

#### Specifications

- 8 1/2' length
- Adjusts from 16" to 30" wide
- Built-in no back bar
- Greasable pivot points
- Full catwalk
- 6 locking points

Scan The QR Code Below To Watch A Video On Proper Cattle Handling



Watch a demonstration of proper cattle handling with the Sioux Steel Cattle Chute. Explanation provided by Ron Gill, Associate Department Head at Texas A&M University.



ADJUSTABLE ALLEYS	DESCRIPTION	WEIGHT
<b>S191530</b>	8.5' Adjustable Alley	714 lbs.
<b>S224596</b>	No Back Rump Bar	35 lbs.

**Color: Prairie Gold**

NOTE: All specifications are subject to change or improvement without notice. Contact Sioux Steel for information on delivery and fuel surcharges.

50 000  
PSI

16  
GAUGE

POWDER  
COATED  
TOUGH



## SPLITTING ALLEYS

Three-way exit, one piece constructed splitting alley can be placed anywhere in a stationary system. Alleys adjust from 30" to 20" when used as alley. Rope and pulley system included with spring loaded return gate.

SPLITTING ALLEYS	DESCRIPTION	WEIGHT
<b>S198501</b>	Right-Handed Splitting Alley - 8.5'	985 lbs.
<b>S198500</b>	Left-Handed Splitting Alley - 8.5'	985 lbs.



**Top View**  
Of left-handed splitting alley

**Left Handed Splitting Alley - 8.5'**  
Product: S198500

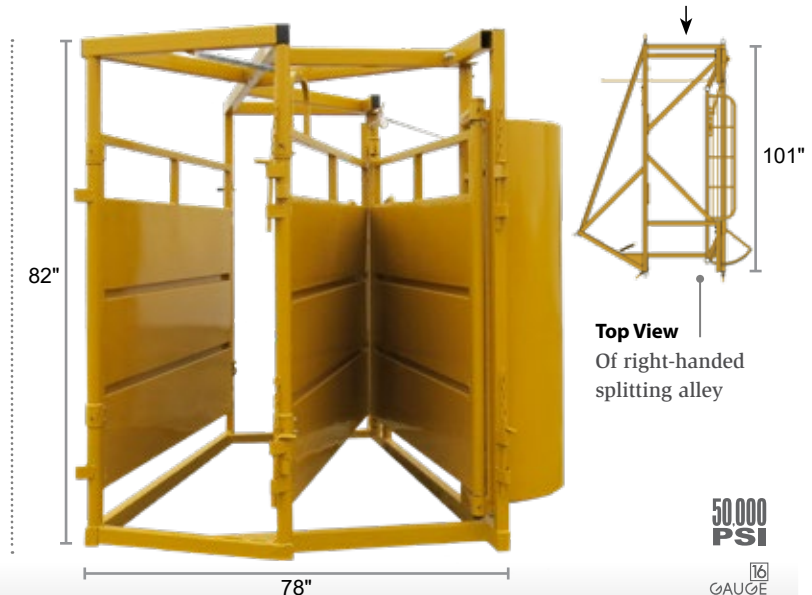

**Top View**  
Of right-handed splitting alley

**Right Handed Splitting Alley - 8.5'**  
Product: S198501



SIoux STEEL PRODUCTS ARE MADE IN THE USA

## IN-LINE GATE

IN-LINE GATE	DESCRIPTION	WEIGHT
<b>S224067</b>	Scissor Style In-Line Gate	270 lbs.

Stand alone or add to short chute and other Sioux Steel working equipment. Operates in all weather conditions.

### Features

- Doors are removable and can be reversed if desired.
- Scissor style gate provides more control of cattle in alley requiring less handling time and effort.
- Less effort required to open or close gate.
- Dual handles allow gate to be opened from either side for greater versatility.



## SLICK DOOR

SLICK DOOR	DESCRIPTION	WEIGHT
<b>S229228</b>	Pin On Slick Door	295 lbs.

### Color: Prairie Gold

NOTE: All specifications are subject to change or improvement without notice. Contact Sioux Steel for information on delivery and fuel surcharges.

Easily mount a slick door to a squeeze chute, any size alley and palp cages with the pin on feature.

A rope and pulley system is utilized to open and close the slick door while working cattle.



# EQUIPMENT

## SQUEEZE CHUTES

### SQUEEZE CHUTE - AUTO HEAD GATE

Designed to accommodate virtually all your cattle from young calves to bigger bulls. This equipment is designed to help keep your livestock calm while being worked.

SC - AUTO HG CLEATED FLOOR	DESCRIPTION	WEIGHT
S191440PG	Squeeze Chute w/Auto HG, Palp Cage, Slick Door & Cleated Floor	2,150 lbs.

- Cleated Floor
- Palp Cage
- Slick Door
- Auto Head Gate



#### WATCH A VIDEO!

Scan this QR code with your smartphone to watch a video demonstration of this product.



Now available with palp cage doors that are bolted on and can move to open in opposite direction! (Squeeze Chute model S191440LH, head gate not included.)

**Squeeze Lever**  
Swings away allowing the side of the chute to open even when squeezed down.

**Parallel Sides**  
Squeeze the animal at the ribs. This helps to keep the animal more stable, comfortable, and quiet.

**Drop Down Doors**  
3 drop down doors have blinders on them to keep the animal focused in the right direction. Doors go all the way down giving you complete access to the upper 2/3rds of the animal.

**Reversed Palp Cage Door**  
Doors open on either side of the palp cage and can move inward or outward for sorting or blocking purposes.

**50,000 PSI**  
16 GAUGE  
POWDER COATED TOUGH

**Full Opening Side Doors**  
If an animal drops down, you have the ability to release an animal out the side.

**Bottom Access Nursing Doors**  
Lower nursing doors open for new born calves or lower extremity access.

**ASK US ABOUT OUR NEW 8 YEAR WARRANTY ON SQUEEZE CHUTES & HEAD GATES!**

#### Specifications

- 84" tall x 38" wide x 12' long
- 9' squeeze chute
- 3' palpation cage
- 29" inside width (squeezes to 12")
- 40 grease zerks
- All panels are a slam latch design
- Both sides open completely
- Controls can be mounted & ran from either side of your operation



W: [www.siouxsteel.com](http://www.siouxsteel.com) // T: 1-877-782-3073 // E: [info@siouxsteel.com](mailto:info@siouxsteel.com)



Photo courtesy of  
@sr33daniels on Instagram



# EQUIPMENT

HEAD GATES, SQUEEZE CHUTES & ACCESSORIES

## SQUEEZE CHUTE - MANUAL HEAD GATE

**LEFT HANDED MANUAL HEAD GATE IS STANDARD.**

Right handed option must be specified at time of order. Left or right handed operations are determined by facing forward the same way cattle would be facing in the head gate.

SC - MAN HG CLEATED FLOOR	DESCRIPTION	WEIGHT
S191440MLHPG	Squeeze Chute W/Manual HG, Palp Cage, Slick Door & Cleated Floor	2,250 lbs.

- Cleated Floor
- Palp Cage
- Slick Door
- Manual Head Gate

Now available with palp cage doors that are bolted on and can moved to open in opposite direction! (Squeeze Chute model S191440LH, head gate not included.)



### VIDEO DEMO

Scan this QR code with your smartphone to watch a video demonstration of this product.

**50,000 PSI**

**GAUGE**

POWDER COATED TOUGH

**LEFT HANDED OPERATION PICTURED**

**3 Drop Down Doors**

Each door has blinders on them to keep the animal focused in the right direction. Doors go all the way down giving you complete access to the upper 2/3rds of the animal.

**Reversed Palp Cage Door**

Doors open on either side of the palp cage and can move inward or outward for sorting or blocking purposes.

**Cleated Floor**

Floors strategically keep animals from slipping. Flooring is quieter and more natural for animals to walk on.

**12" Injection Door**

Our injection door is the largest in the industry, allowing for greater access to the neck area making vaccinations and injections safer and easier for both the animal and the processors.

**52" Fiberglass Push Bar**

Easily move the animal forward into the squeeze chute. This unique process allows producers to leverage animals forward without having to remove push bar into new slot.

ASK US ABOUT OUR **NEW**

**WARRANTY**

**8 YEAR**

**WARRANTY**

ON SQUEEZE CHUTES & HEAD GATES!

### Specifications

- 84" tall x 38" wide x 12' long
- 9' squeeze chute
- 3' palpation cage
- 29" inside width (squeezes to 12")
- 40 grease zerks
- All panels are a slam latch design
- Both sides open completely
- Can be ordered in left or right handed operations.



W: [www.siouxsteel.com](http://www.siouxsteel.com) // T: 1-877-782-3073 // E: [info@siouxsteel.com](mailto:info@siouxsteel.com)



Photo courtesy of  
[@3bcattleco.nc](https://www.instagram.com/3bcattleco.nc) on Instagram



## AUTO HEAD GATE

Spring cushion mounted on squeeze chute to reduce impact when the animal runs into the head gate.

AUTO HEAD GATE	DESCRIPTION	WEIGHT
S198400	Self-Catching Automatic Head Gate	277 lbs.



Left or right handed operation.

Quickly and easily adjusted automatic, self-catch head gate.

When a cow goes through, the head gate resets itself automatically.

Head gate is adjustable from 4" to 10.5".



## NOSE BAR

Bar swings across the front to hold the head in a firm position while working. Bars swing out of the way for animal exit.

NOSE BAR	DESCRIPTION	WEIGHT
S229088RD	Nose Bar	41 lbs.



Can only be utilized with automatic head gates. (Head gate sold separately.)

Cattle do not have the ability to move their head while ear tags or horns are removed, and while veterinarian work is being performed.



## PALP CAGE

The palp cage can be used for sorting animals or block the passage while working on the animal in the chute.

PALP CAGE	DESCRIPTION	WEIGHT
S202547	3' Palp Cage Less Slick Door	260 lbs.



Doors open on either side of the palp cage and can move inward or outward for sorting or blocking purposes.

Make the width of the palp cage smaller by one foot by adding palp filler panels.



## PALP CAGE FILLER

Utilized on the inside of the palp cage doors, these panels easily hook to the top of the door to decrease the total width of the palp cage.

PALP CAGE FILLER	DESCRIPTION	WEIGHT
S197610PG	Palp Cage 6" Filler Panel	20 lbs.

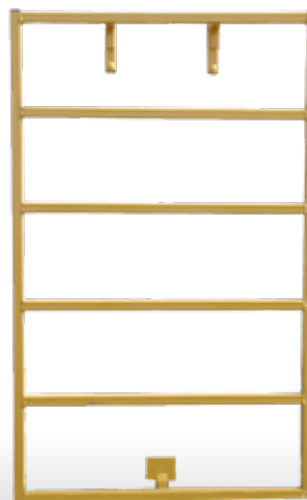

Each filler panel is 6" in depth. Add 2 panels to the palp cage to decrease the total width of the cage by one foot.

Keeps consistent width from alley to palp cage to chute when equipment is squeezed down.

Helps cattle continue to move forward and prevents them from turning around.







## MANUAL HEAD GATE

Controls can be mounted on either side of the head gate, accommodating to your cattle working environment.

MANUAL HEAD GATE	DESCRIPTION	WEIGHT
<b>S202800</b>	HD Manual Head Gate - Left Handed	319 lbs.
<b>S208753</b>	HD Manual Head Gate - Right Handed	319 lbs.

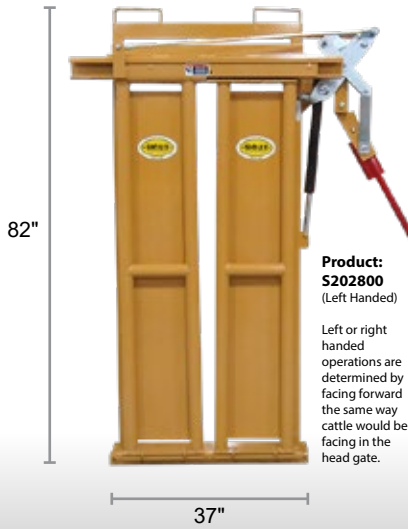

**Product: S202800**  
(Left Handed)

Left or right handed operations are determined by facing forward the same way cattle would be facing in the head gate.

Left or right handed operation.

When cattle are in a head gate they tend to put pressure forward or backward on the gate. Simply move the lever on the manual head gate and open the check valve and it will open.

50,000  
PSI

16  
GAUGE

POWDER  
COATED  
TOUGH

## HEAD CATCH

Quickly & easily secure a cow's head for handlers and veterinarians access to the animal to administer medication, replace tags, monitor well being, and various other tasks. Can only be used with manual head gates. (Head gate sold separately.)

Locking mechanism allows for catching the animals head with one hand.

With friction bar, Head Catch can be locked in any position, making it adjustable to working both cattle & calves.

Entire unit has 5 mounting positions allowing for 10 inches of vertical movement to accommodate different cattle sizes.

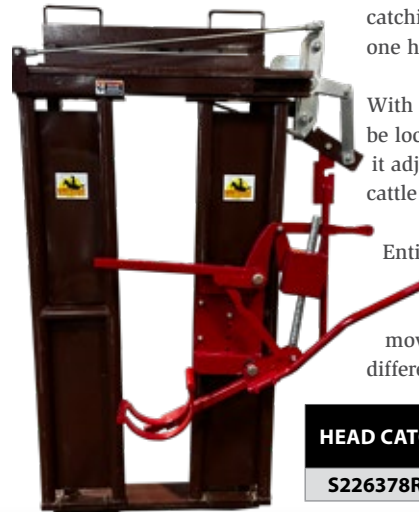

HEAD CATCH	DESCRIPTION	WEIGHT
<b>S226378RD</b>	Head Catch	81 lbs.

POWDER  
COATED  
TOUGH



Photo courtesy of @j.j.scheckelangus on Instagram



**FIND YOUR LOCAL  
SIOUX LIVESTOCK DEALER**

Scan this QR code to search for the nearest livestock dealer in your area.



Maiden voyage and blue Iowa skies for our 2nd Sioux Steel Chute setup, very happy with Sioux for the last 15 years. This one has a manual head gate, and true test weigh bars, our 1st one has an auto catch, which we still use at another farm location, it's still in great shape and going strong after thousands and thousands of catches.

*J.J. Scheckel  
Performance Angus Genetics  
Bellevue, IA*

## LESS PALP CAGE - CLEATED FLOOR

Enjoy all the features of our squeeze chute system, minus the palp cage & slick door option. Cleated floor is standard on this system.

SC - AUTO HG LESS PALP	DESCRIPTION	WEIGHT
S202535AHPG	Squeeze Chute w/Auto Head Gate, & Cleated Floor	1,485 lbs.

**S202535 MLHPG**  
Short Chute with LH Manual HG

**S202535 MRHPG**  
Short Chute with RH Manual HG

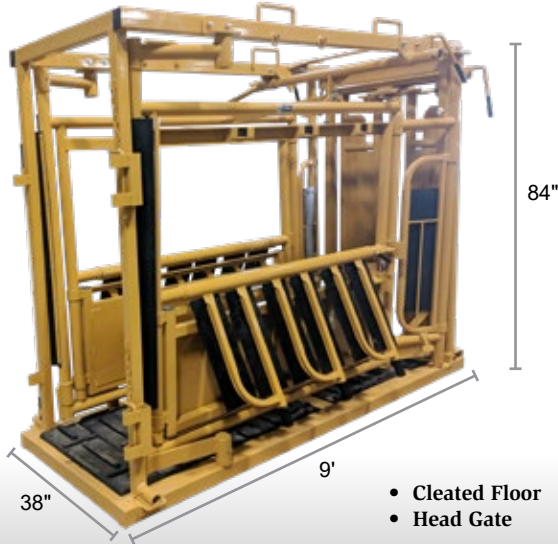

- Cleated Floor
- Head Gate

## BRISKET BAR

Helpful tool in keeping animals from going down in the chute.

BRISKET BAR	DESCRIPTION	WEIGHT
S221291PG	Brisket Bar for One-Piece Cleated Floor*	18 lbs.

\*For chutes purchased 2017 or later.



SIoux STEEL PRODUCTS ARE MADE IN THE USA

## SCALES

Easy and convenient to get fast, accurate weights on your cattle while in the alley. **ONLY AVAILABLE ON 8.5' ALLEYS.**

SCALE SYSTEMS	DESCRIPTION	WEIGHT
S196888	Digital Indicator (SW600)	6 lbs.
S196870	Digital Indicator (SW300)	6 lbs.
S196564PG	Digital Indicator Mount	8 lbs.
S196887	Load Cells	44 lbs.
S197661RC	Scale Platform	140 lbs.

Digital Indicator & Mount



Load Cells (left) & Scale Platform (right)



## SQUEEZE CHUTE CART

Just wheel up to the squeeze chute and easily transport your system. 2" ball hook up.

SQUEEZE CHUTE CART	DESCRIPTION	WEIGHT
S196450	Squeeze Chute Cart	316 lbs.

Can be utilized on the following products:

- Squeeze Chute with Auto or Manual Head Gate
- Squeeze Chute Less Palp Cage - Cleated Floor
- 8.5 Adjustable Alley





## PORTABLE LOADING CHUTE

32" inside width to accommodate trailers with side loading capability. Torsion Axle with 5,000 lb load capacity. 2" ball coupler.

LOADING CHUTE	DESCRIPTION	WEIGHT
S230164	Portable Loading Chute	1,250 lbs.



Cable winch adjusts loading height from 48" to 57".

Cleated rubber floor keeps animals from slipping.

Side access door can be used to close off loading chute.

Prodding slot to assist movement of animals.

Tongue is removable via a hitch pin when set up in loading position.

**Outside Width: 80"**    **Wheels: 225/75D15**  
**Inside Width: 32"**    **Deck Length: 155"**

NOTE: All specifications are subject to change or improvement without notice.



SIoux STEEL PRODUCTS ARE MADE IN THE USA



*Squeeze Chute*  
**CART**





196 1/2 E. 6th St. • Sioux Falls, SD • 1-800-557-4689 • [www.siouxsteel.com](http://www.siouxsteel.com)



Interested in working for Sioux Steel Company?  
Scan this QR Code with your smartphone to e-mail  
us for our current employment opportunities.



**WARRANTY INFORMATION:** Sioux Steel products come standard with a limited one year warranty on steel products and a limited two year warranty on poly products. All gates with the Lifetime Warranty sticker have a lifetime warranty. Some restrictions may apply. Please contact our customer service team to learn more.



### SHOP ONLINE!

Search local dealerships or buy direct online. MSRP product pricing featured along with additional product information.

[www.agpartsdirect.com](http://www.agpartsdirect.com)

## FOURTH GENERATION, FAMILY-OWNED COMPANY



"I came to this business at the age of 27 years, with a whole lot to prove. Now, some 20 years later, I am proud of what we have created. It is with great pride that I work here, delivering on the promises of my father and grandfather and great grandfather as the 4th generation managing our business."

**SCOTT RYSDON**  
PRESIDENT/CEO & FOURTH GENERATION OWNER

19  
SINCE  
18